

STEP-UP

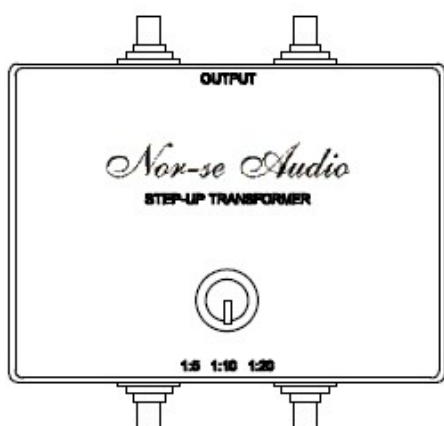
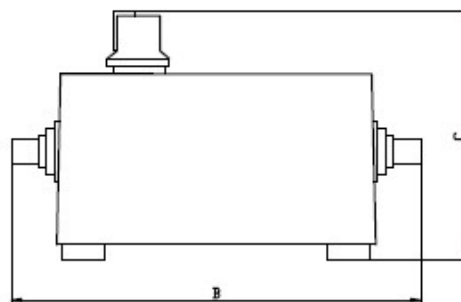
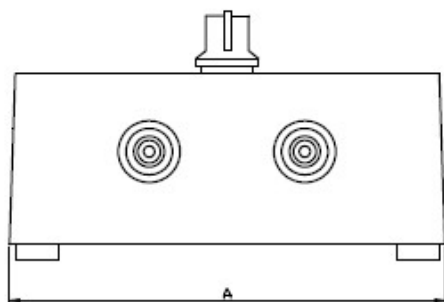

Measurement conditions:

$f = 1 \text{ kHz}$, $V_{out} = 0.01 \div 1.00 \text{ V}$, $Z_{load} = 100 \text{ k}\Omega$, 100 pF

Ratio 1:5, 1:10, 1:20

Harmonic distortion carried out with the following conditions:

$f = 1 \text{ kHz}$, $V_{out} = 10 \text{ mV}$, $Z_{load} = 100 \text{ k}\Omega$, 100 pF

2° harmonic distortion = 0,007%

3° harmonic distortion = 0,001%

4° harmonic distortion = 0,0007%

5° harmonic distortion = 0,0004%

6° harmonic distortion = 0,0005%

7° harmonic distortion = 0,0002%

Bandwidth detected:

2,4 Hz (-1 dB)

0,8 Hz (-3 dB)

MODEL	RATIO	Z load 47k Ω ,100pF	RESPONSE (-1dB)	Z load 47k Ω ,100pF	RESPONSE (-3 dB)	DIMENSIONS (mm)			WHEIGHT (kg)
						A	B	C	
ST2	1:5	47k Ω ,100pF	2,4Hz÷62 kHz	47k Ω ,100pF	0,8Hz÷56k Hz	112	106	64	0,380
ST2	1:10	47k Ω ,100pF	2,4Hz÷48 kHz	47k Ω ,100pF	0,8Hz÷57 kHz	112	106	64	0,380
ST2	1:20	47k Ω ,100pF	2,4Hz÷45 kHz	47k Ω ,100pF	0,8Hz÷54 kHz	112	106	64	0,380

Our step-up, unique of its kind, gives you the possibility to choose between three ratio (1:5, 1:10, 1:20).

This allows to have one product that can be used with any kind of cartridge (MA and/or MM) on the market without using additional resistors.

Provided with a wide bandwidth and with a minimum distortion, it has been carefully designed to optimize listening performances with optimal cleaning of the sound.

Manufacturing techniques and excellent materials allow to delete hum pickups generated by external sources.

Our products are entirely realised in Italy with first choice raw materials strictly selected in order to guarantee the best quality and safety.

<http://nuke.nonsoloaudiofili.com/StepUpNorSeVersione2PartePrima/tabid/649/Default.aspx>

<http://nuke.nonsoloaudiofili.com/StepUpNorSeVersione2ParteSeconda/tabid/650/Default.aspx>

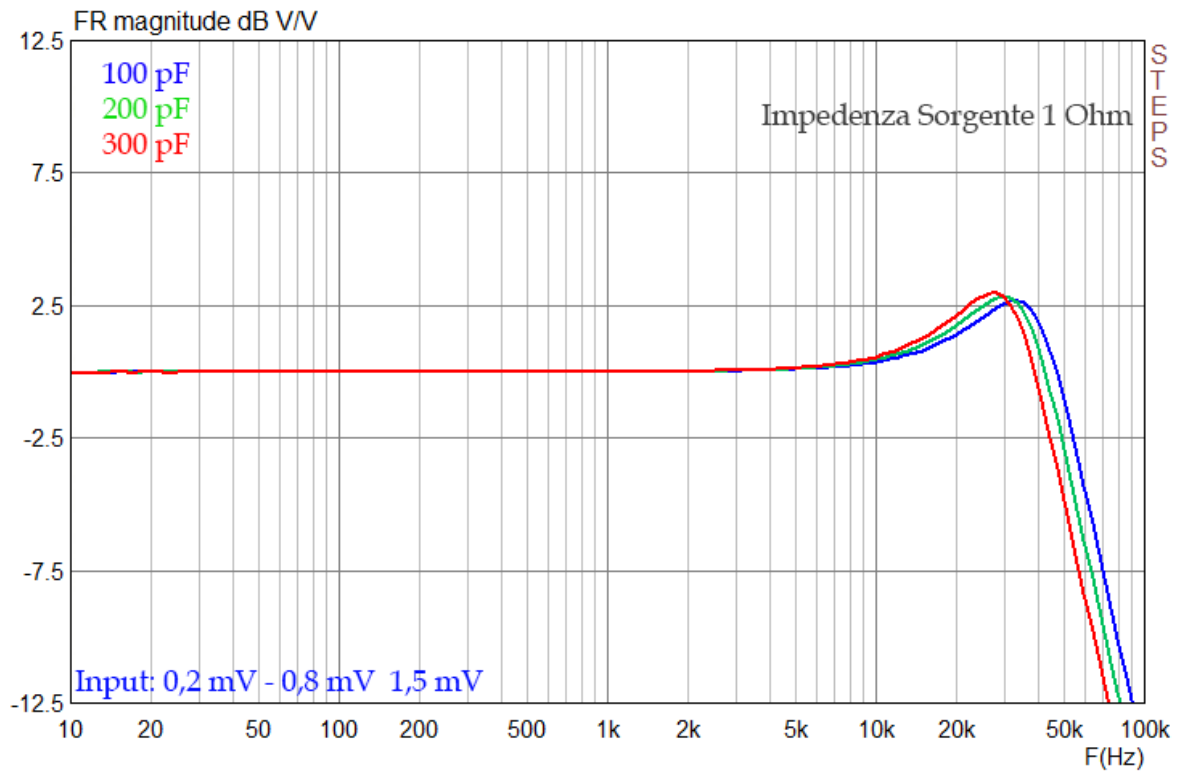

2019-02-27 16:26:27

Step-Up Nor-Se - Risposta in frequenza 1,5 mV / 1:5 / 21,747 kOhm / 100-200-300 pF DPA

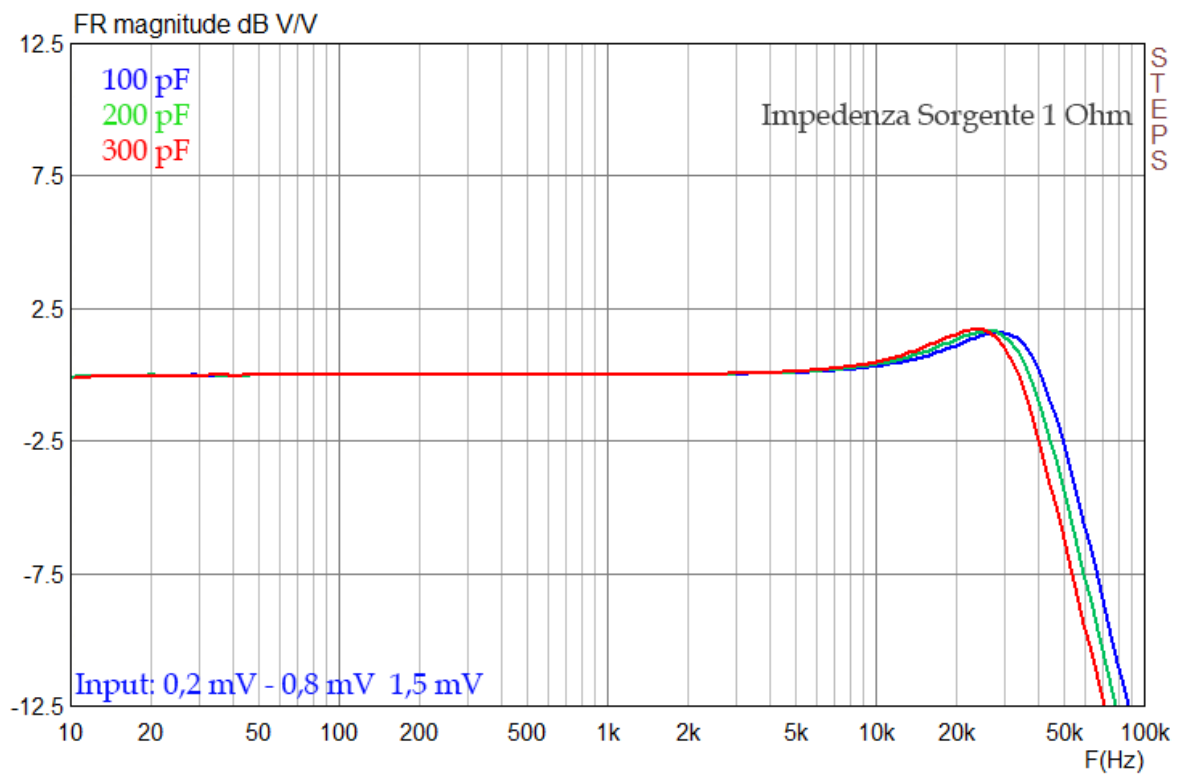

2019-02-27 16:29:24

Step-Up Nor-Se - Risposta in frequenza 1,5 mV / 1:10 / 21,747 kOhm / 100-200-300 pF DPA

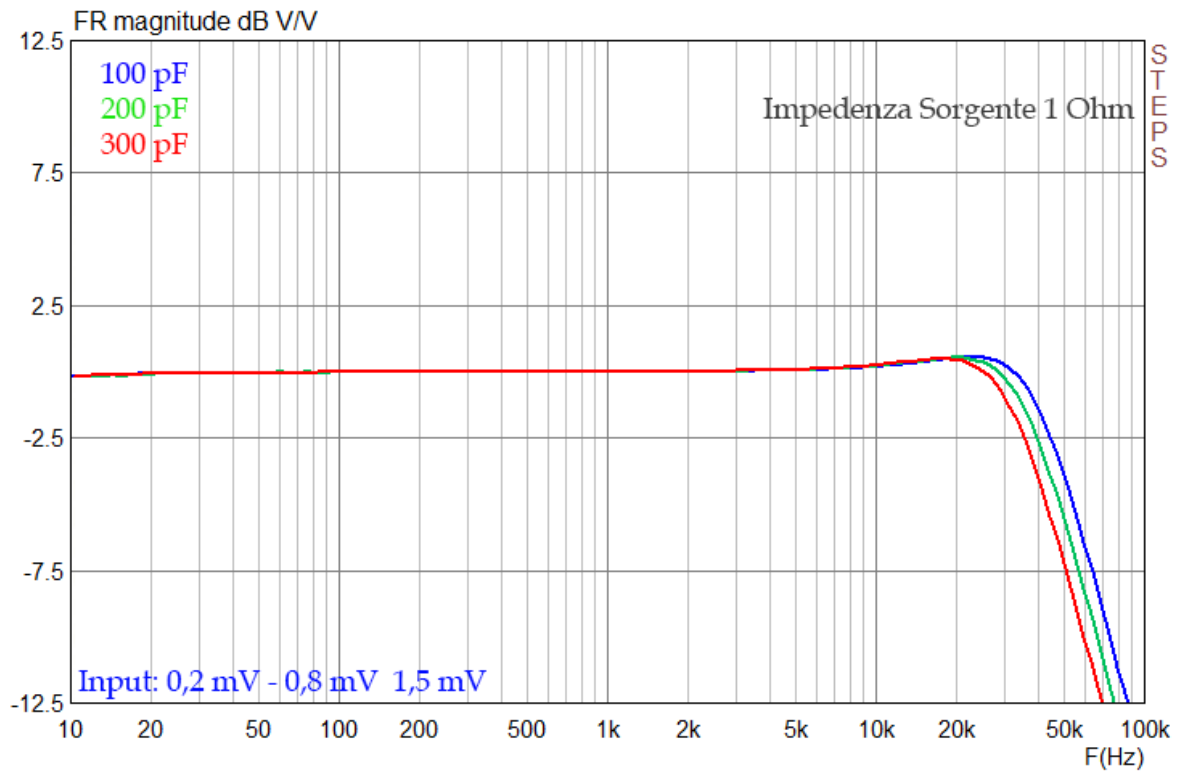

2019-02-27 16:32:16

Step-Up Nor-Se - Risposta in frequenza 1,5 mV / 1:20 / 21,747 kOhm / 100-200-300 pF DPA

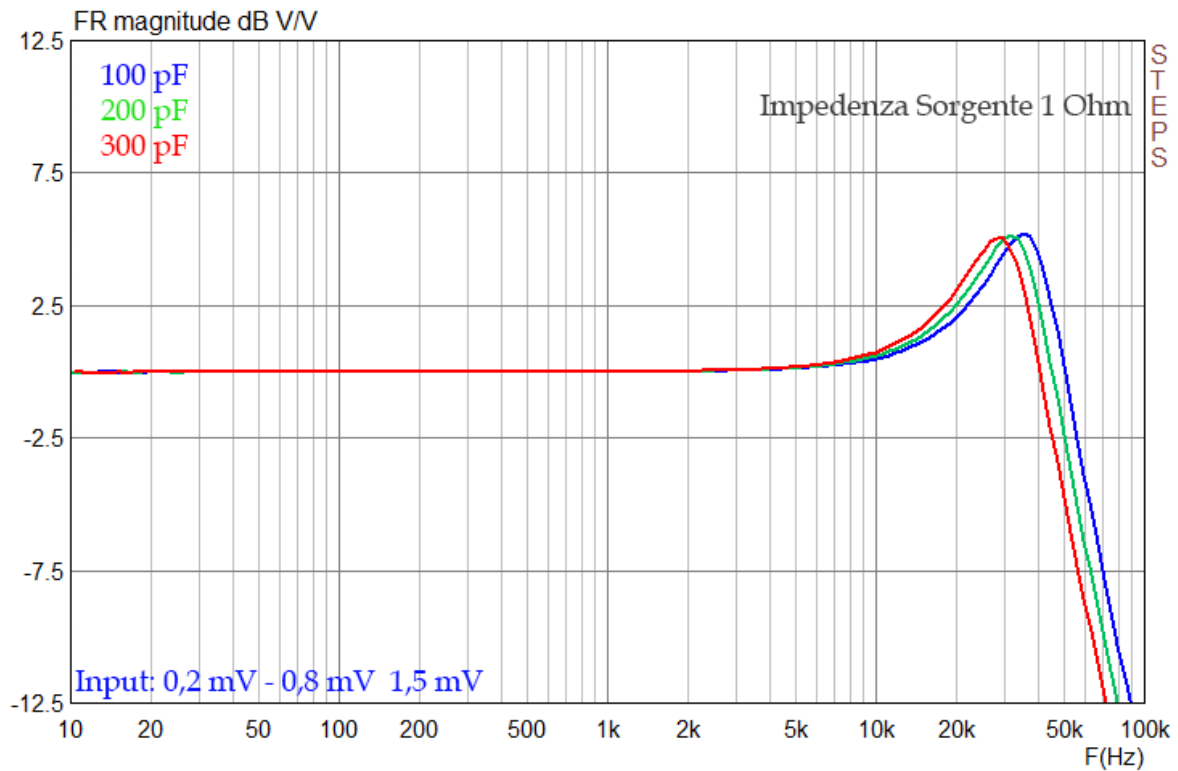

2019-02-27 16:34:50

Step-Up Nor-Se - Risposta in frequenza 1,5 mV / 1:5 / 47 kOhm / 100-200-300 pF DPA

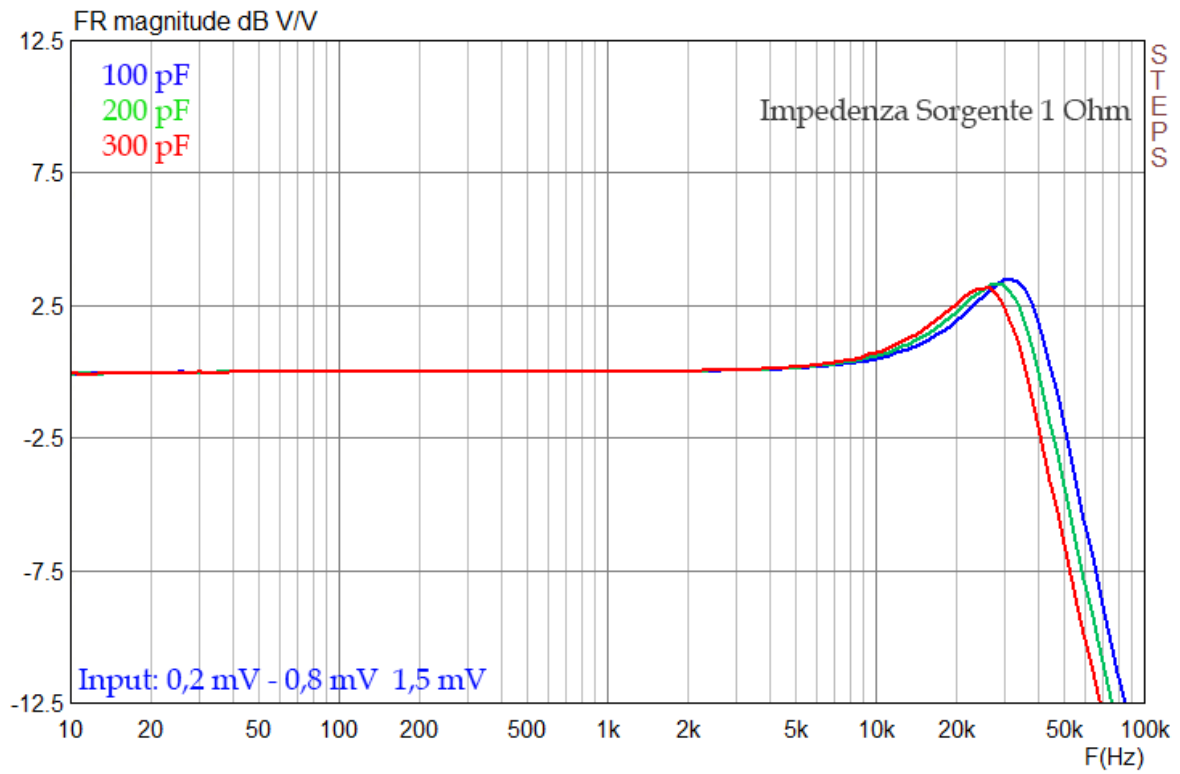

2019-02-27 16:37:12

Step-Up Nor-Se - Risposta in frequenza 1,5 mV / 1:10 / 47 kOhm / 100-200-300 pF DPA

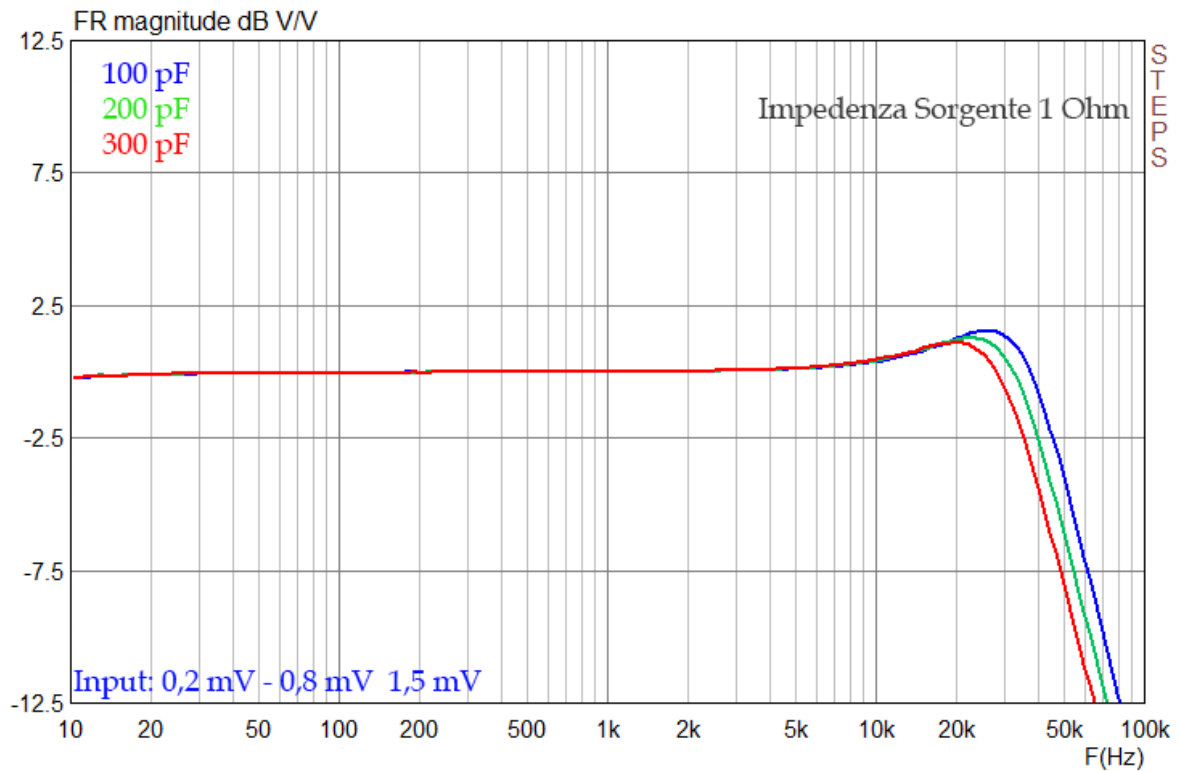

2019-02-27 16:39:32

Step-Up Nor-Se - Risposta in frequenza 1,5 mV / 1:20 / 47 kOhm / 100-200-300 pF DPA

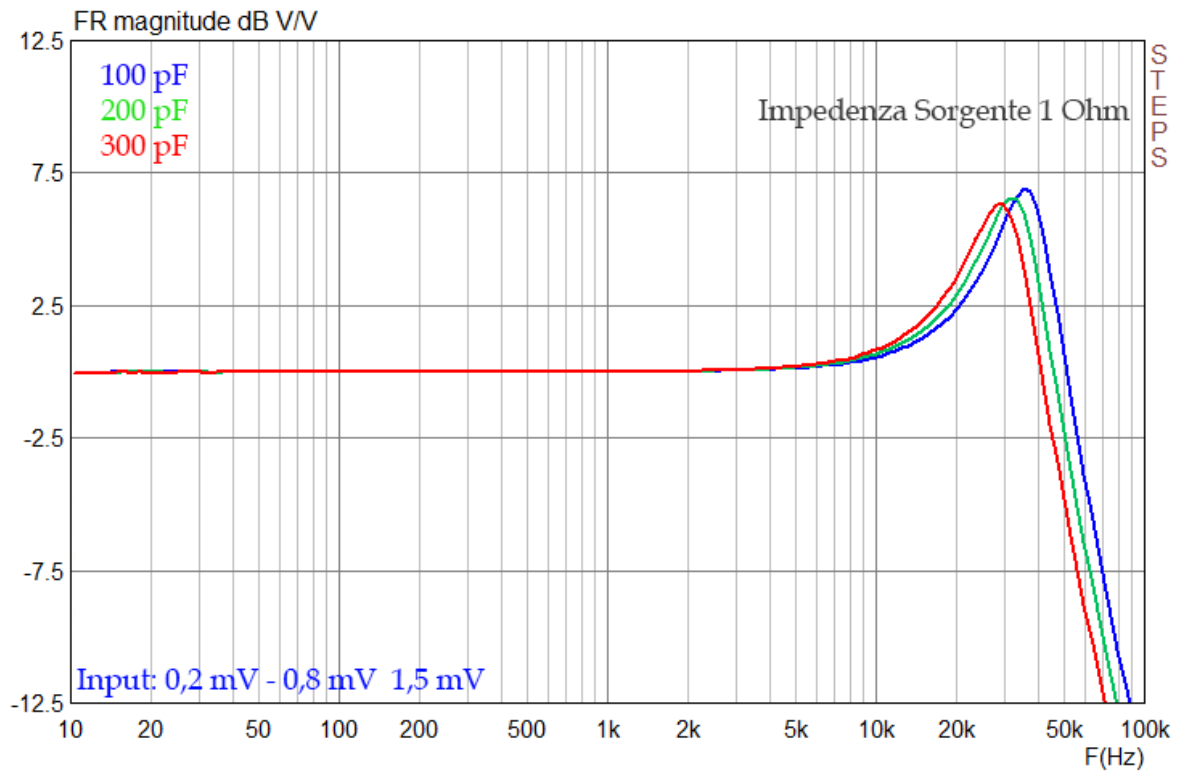

2019-02-27 16:42:08

Step-Up Nor-Se - Risposta in frequenza 1,5 mV / 1:5 / 100 kOhm / 100-200-300 pF DPA

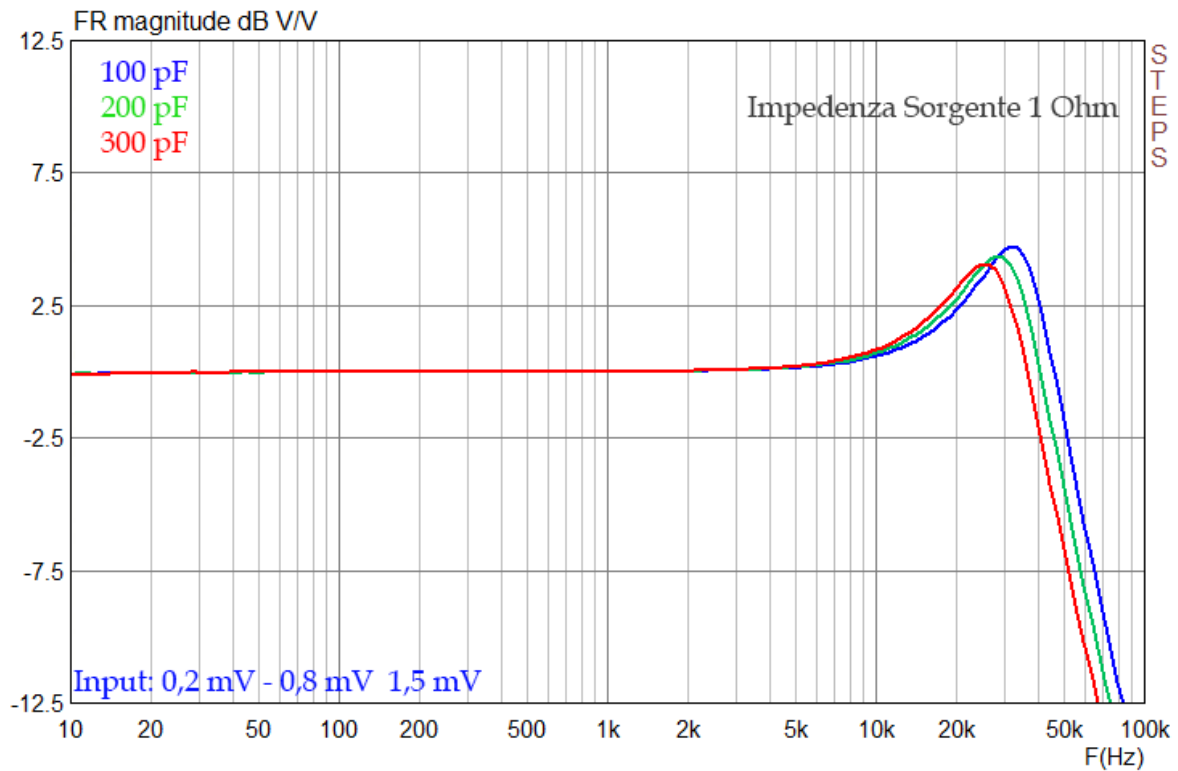

2019-02-27 16:46:59

Step-Up Nor-Se - Risposta in frequenza 1,5 mV / 1:10 / 100 kOhm / 100-200-300 pF DPA

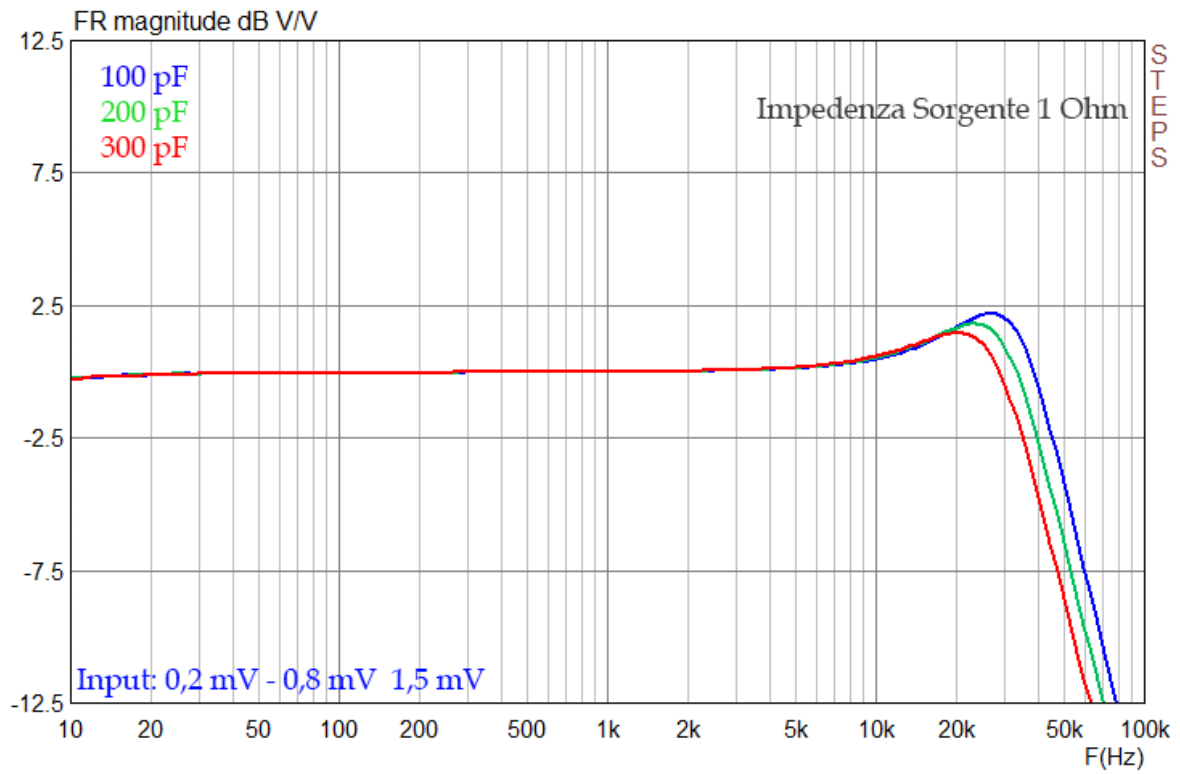

2019-02-27 16:49:21

Step-Up Nor-Se - Risposta in frequenza 1,5 mV / 1:20 / 100 kOhm / 100-200-300 pF DPA

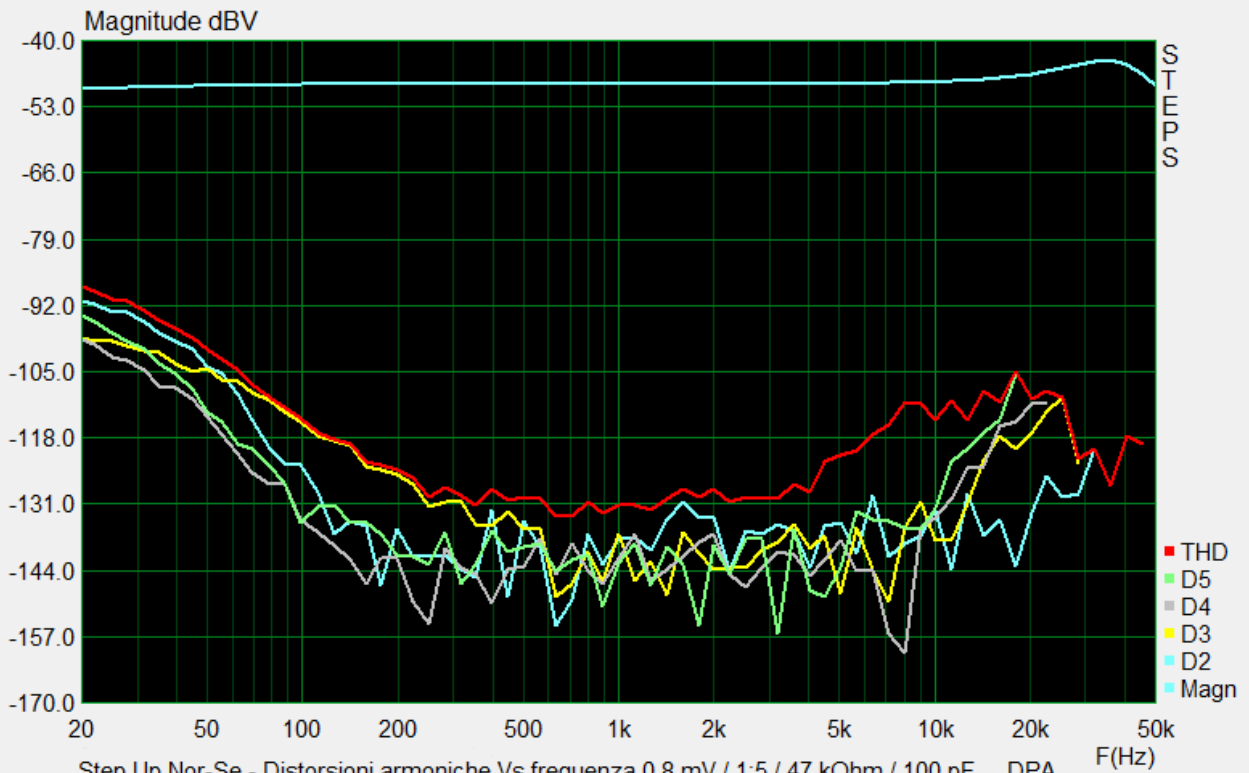

2019-02-27 17:10:47

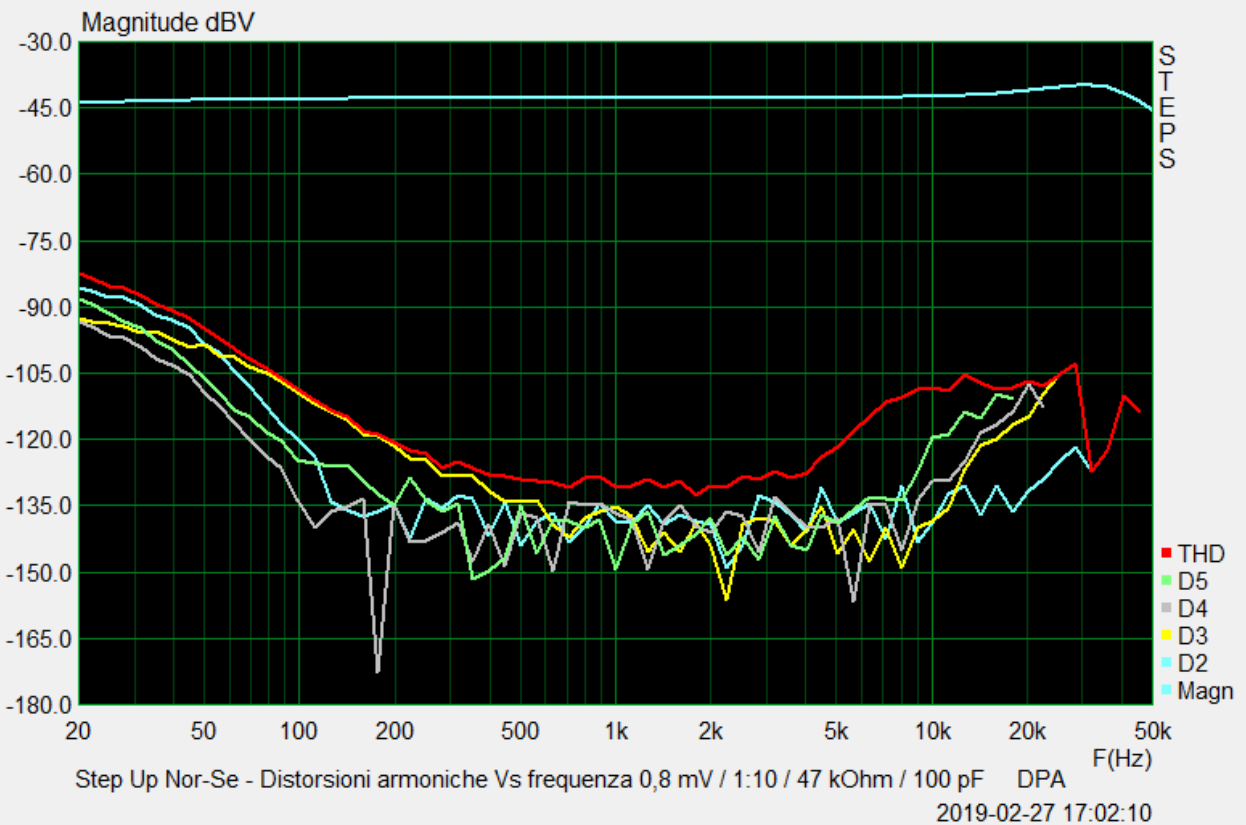
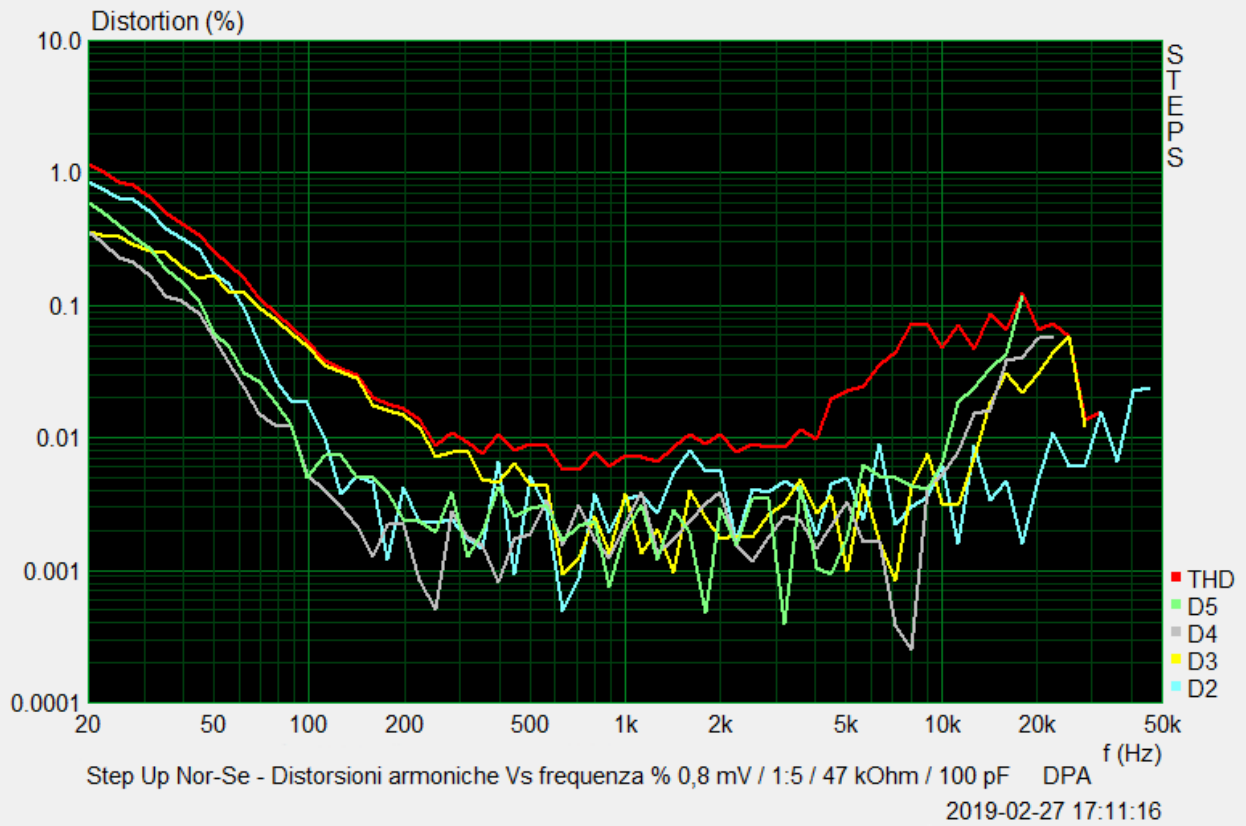

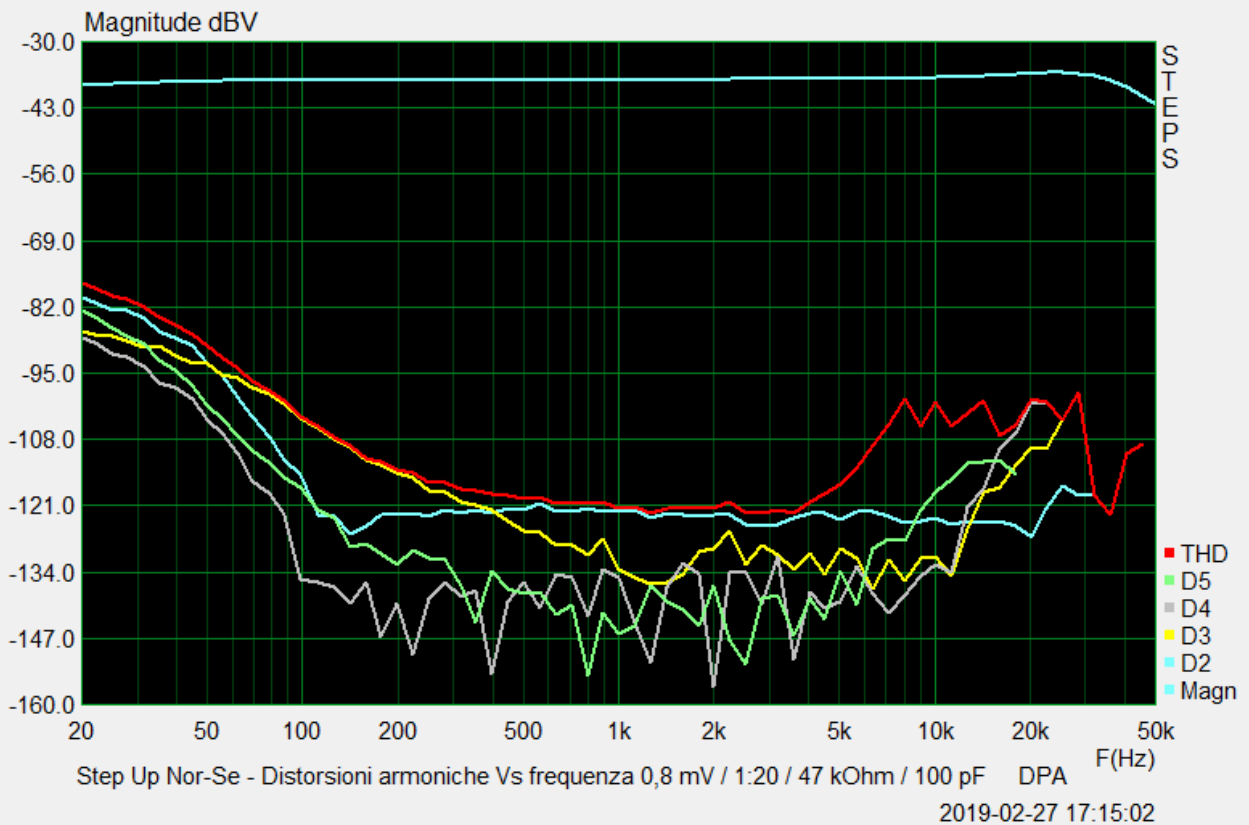
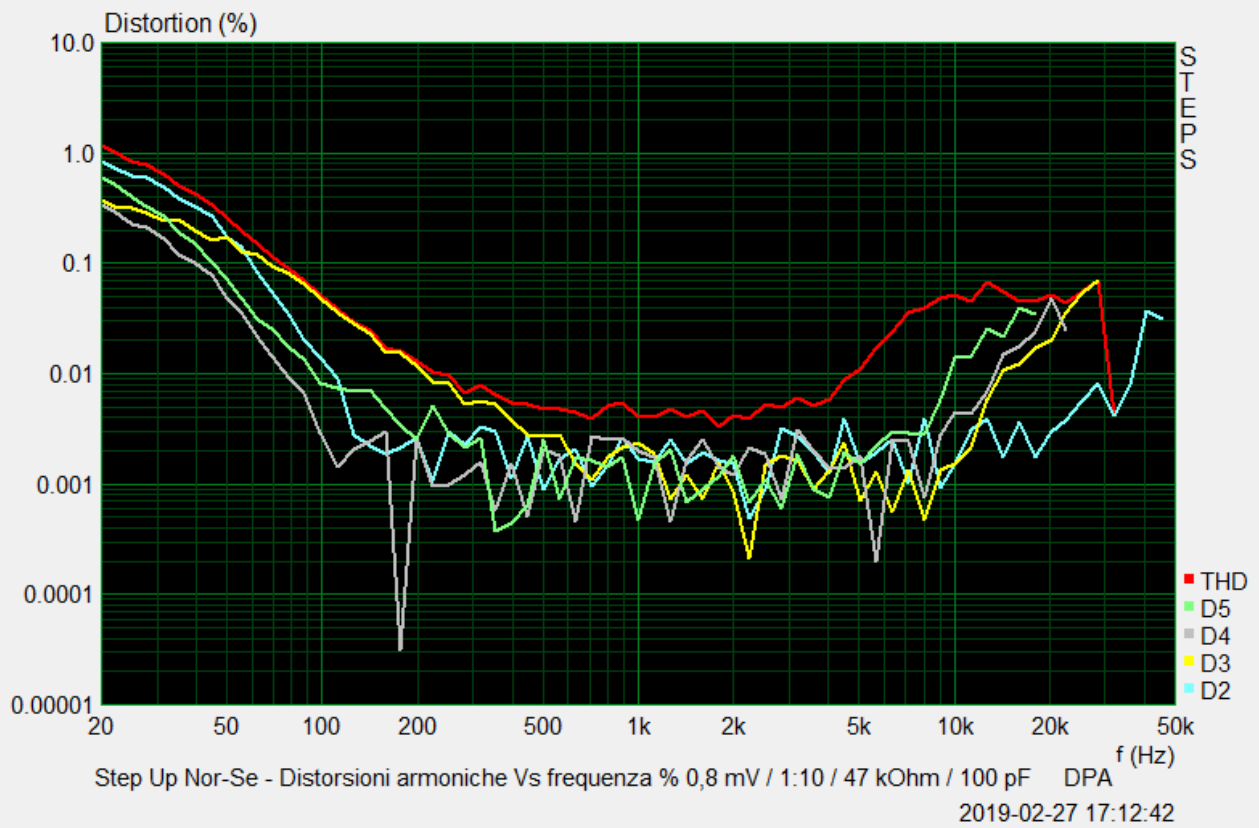

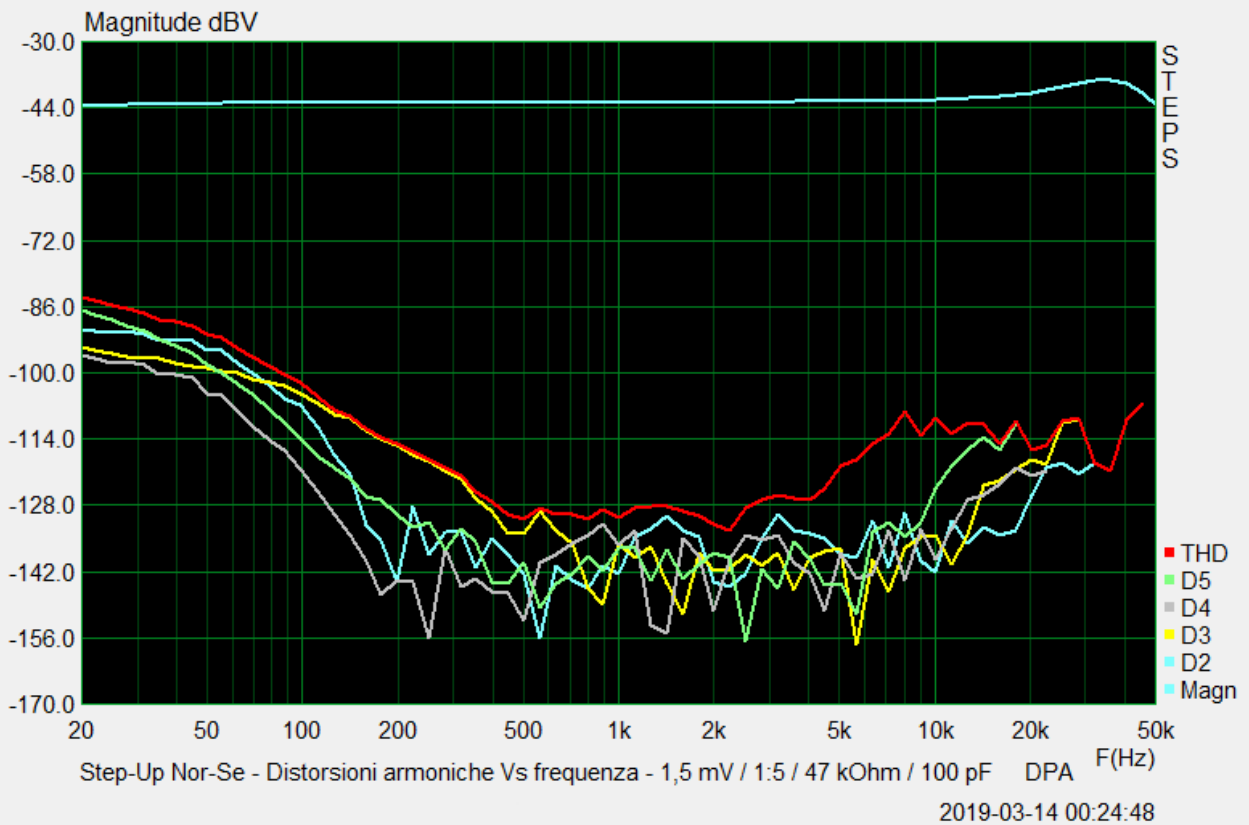
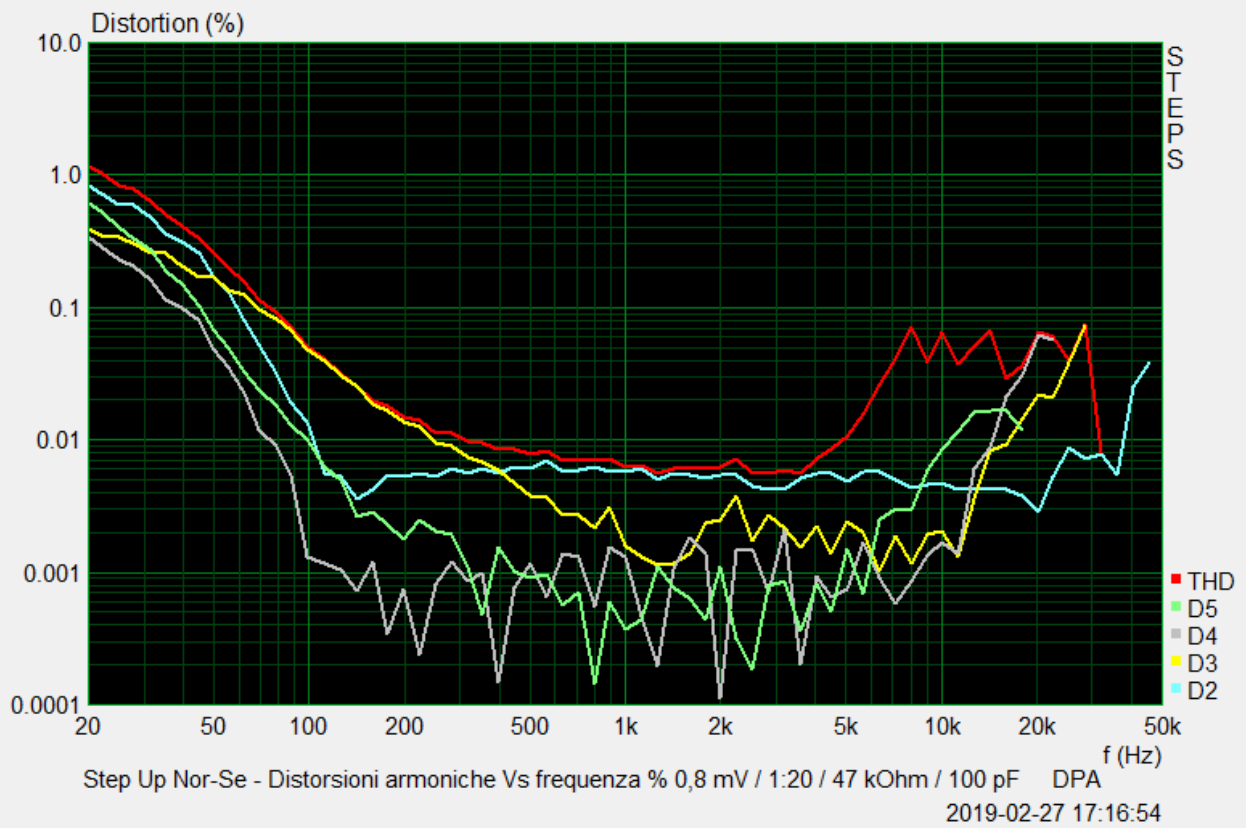

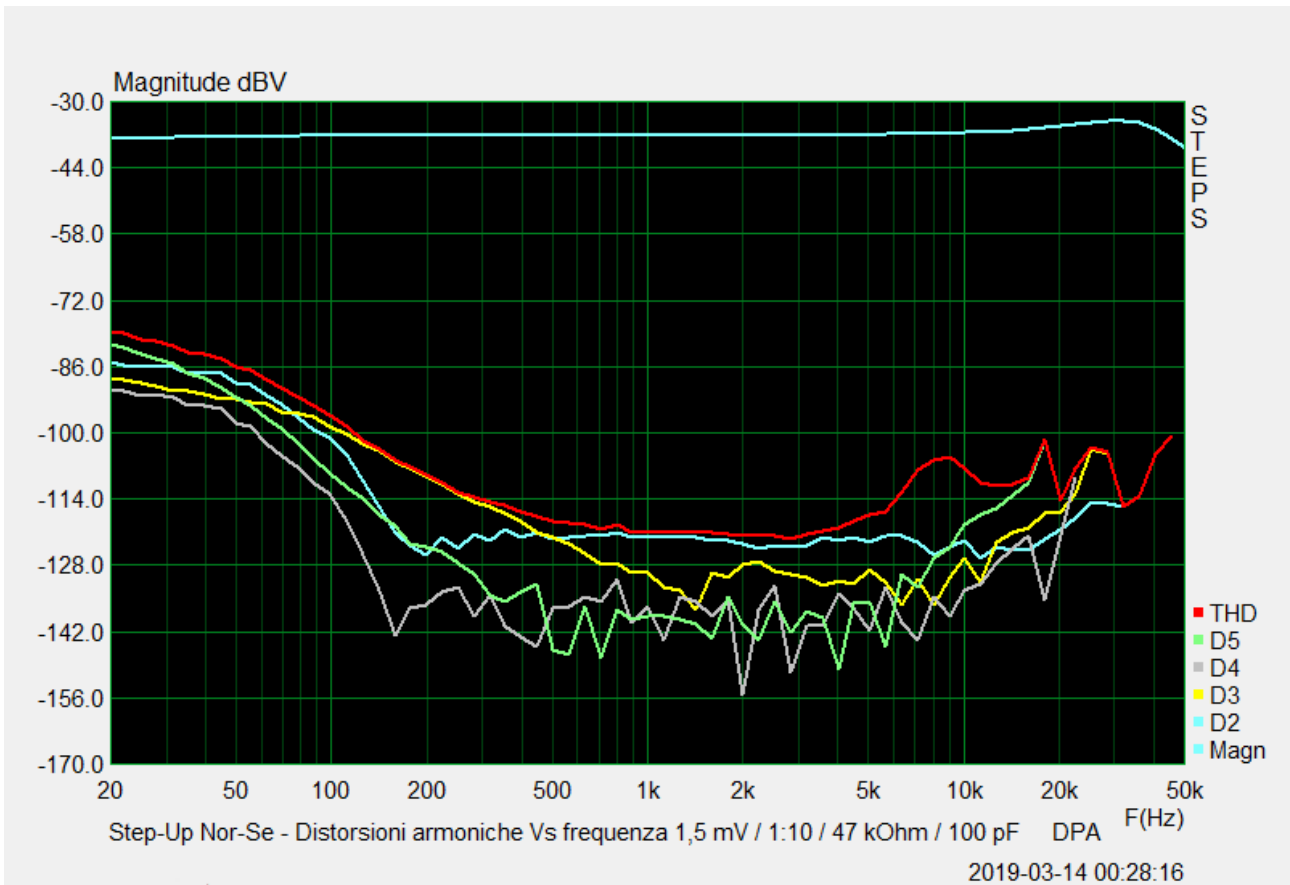
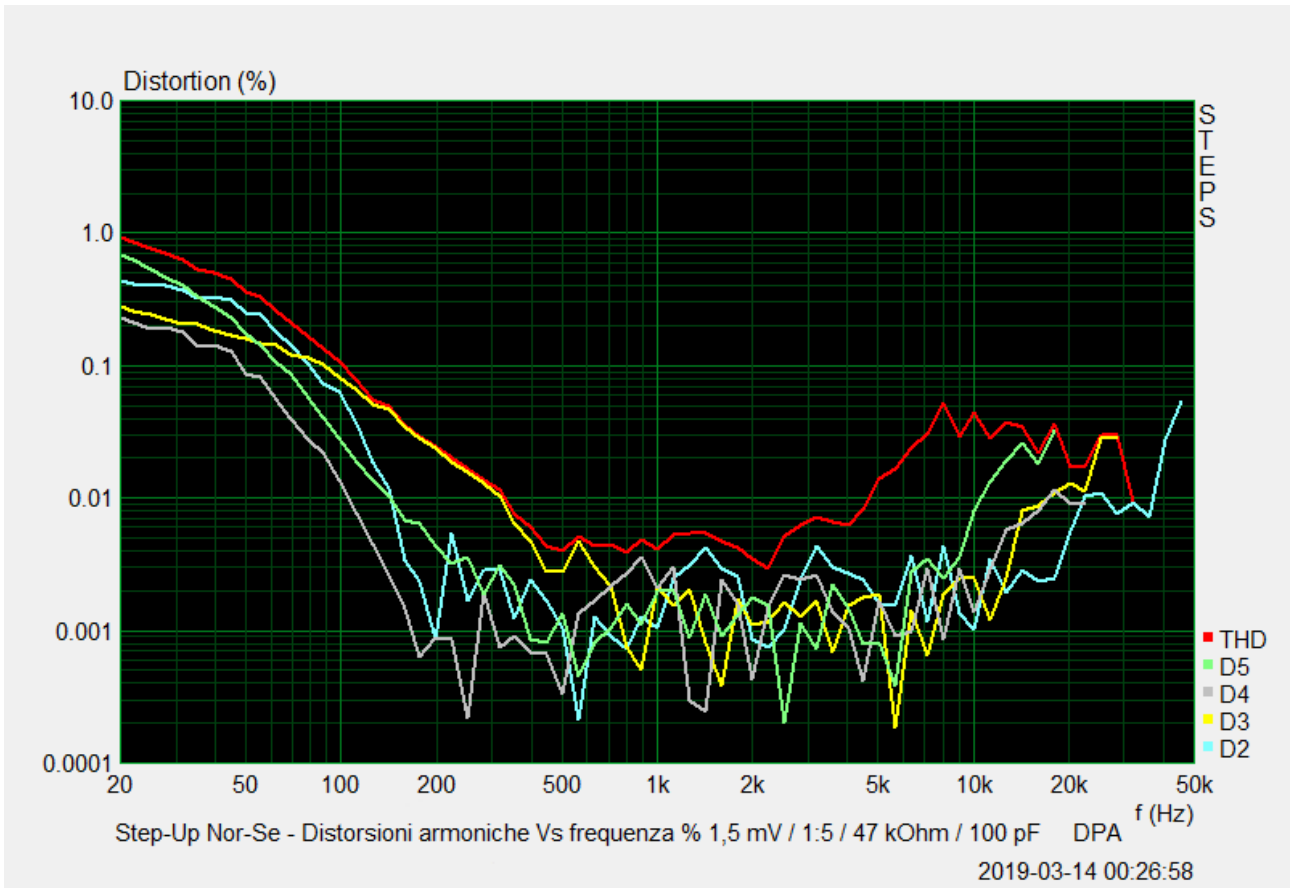

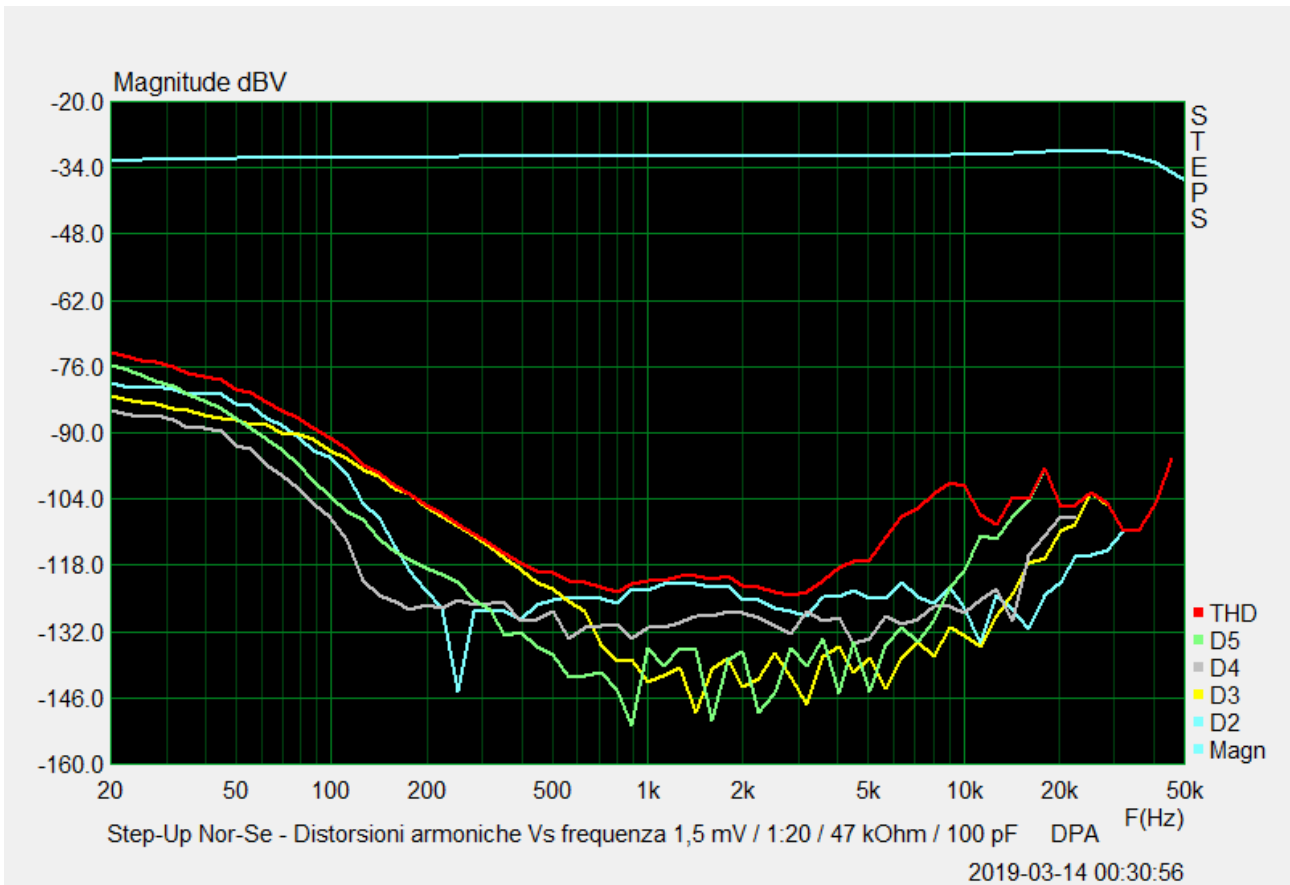
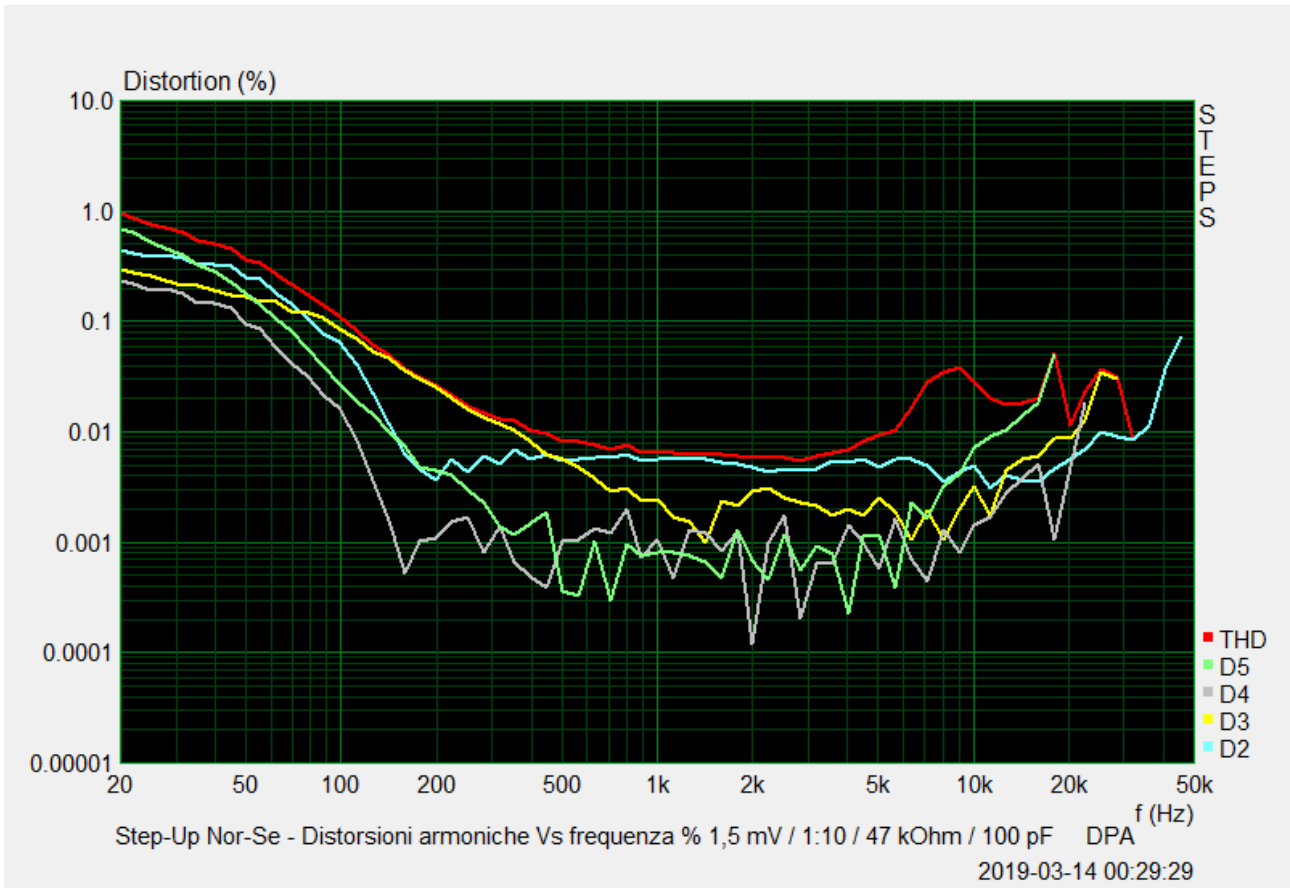

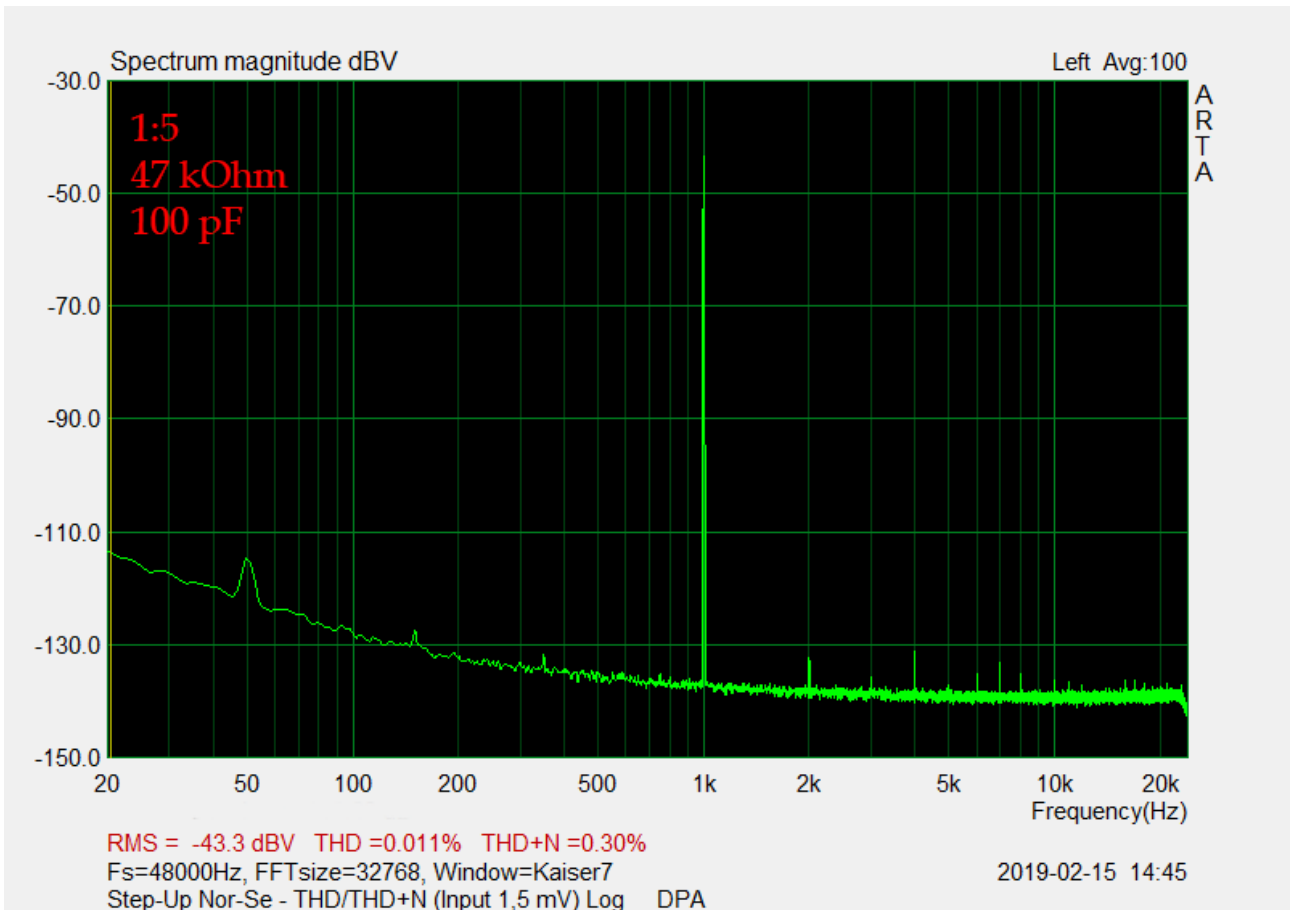
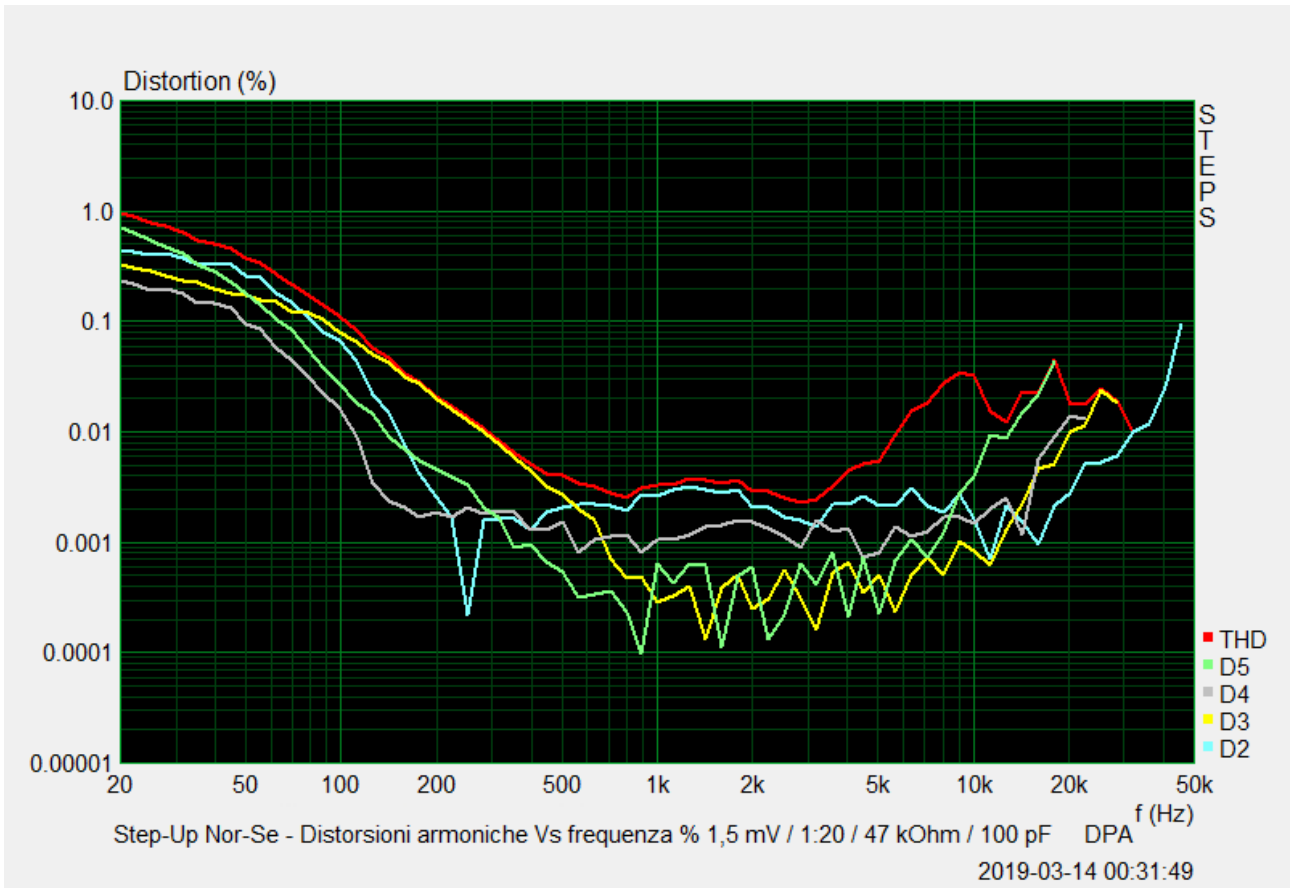

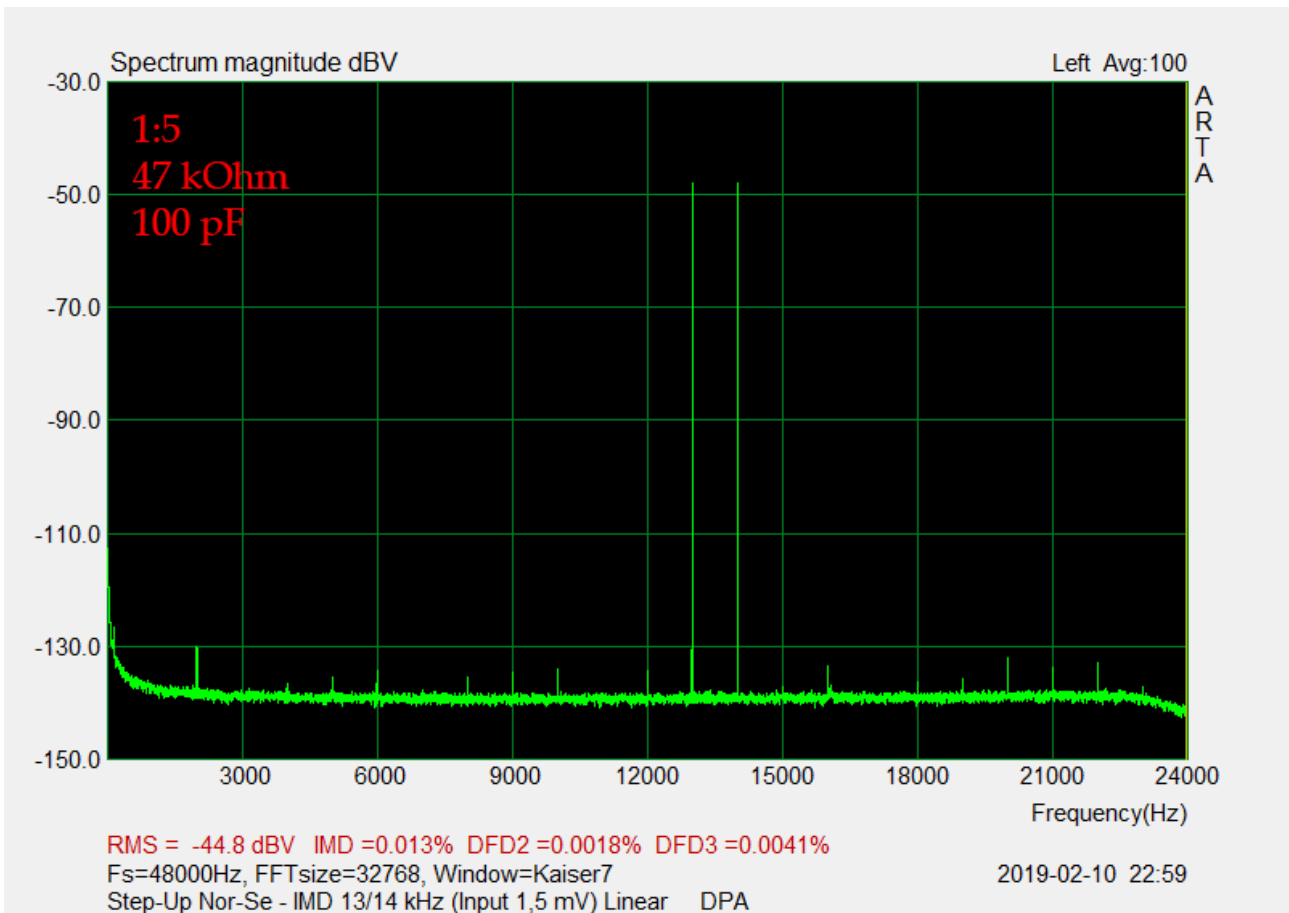
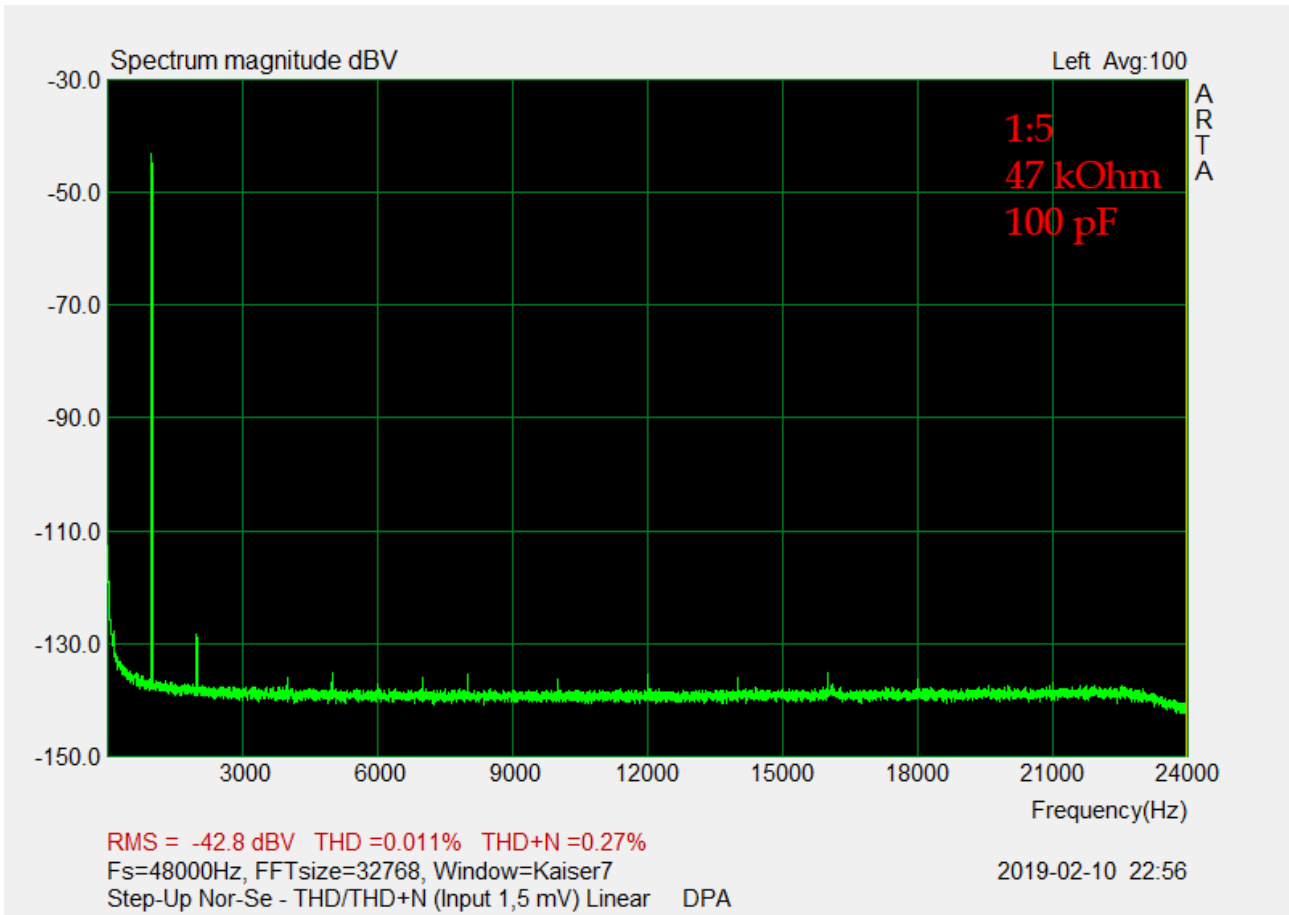

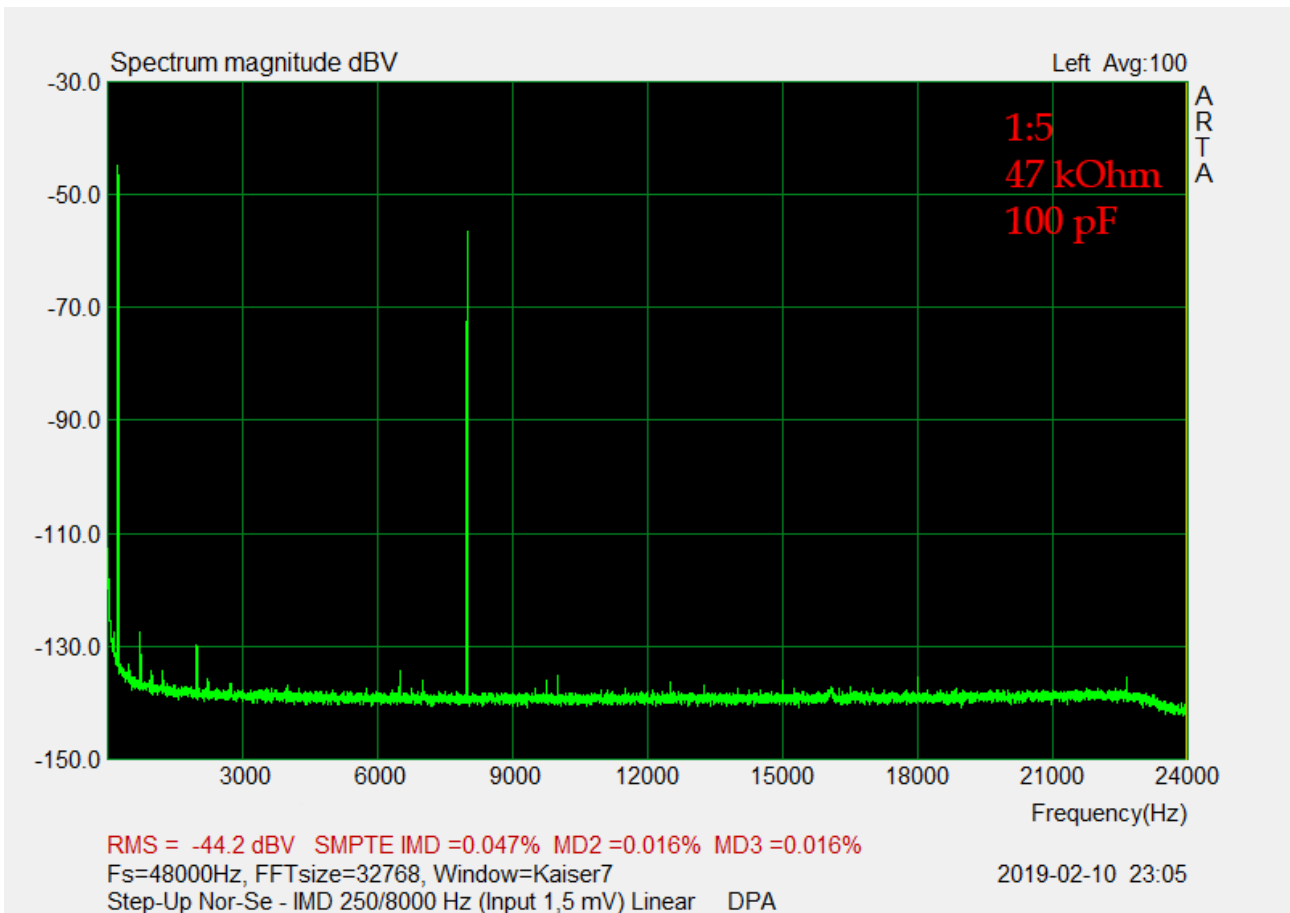
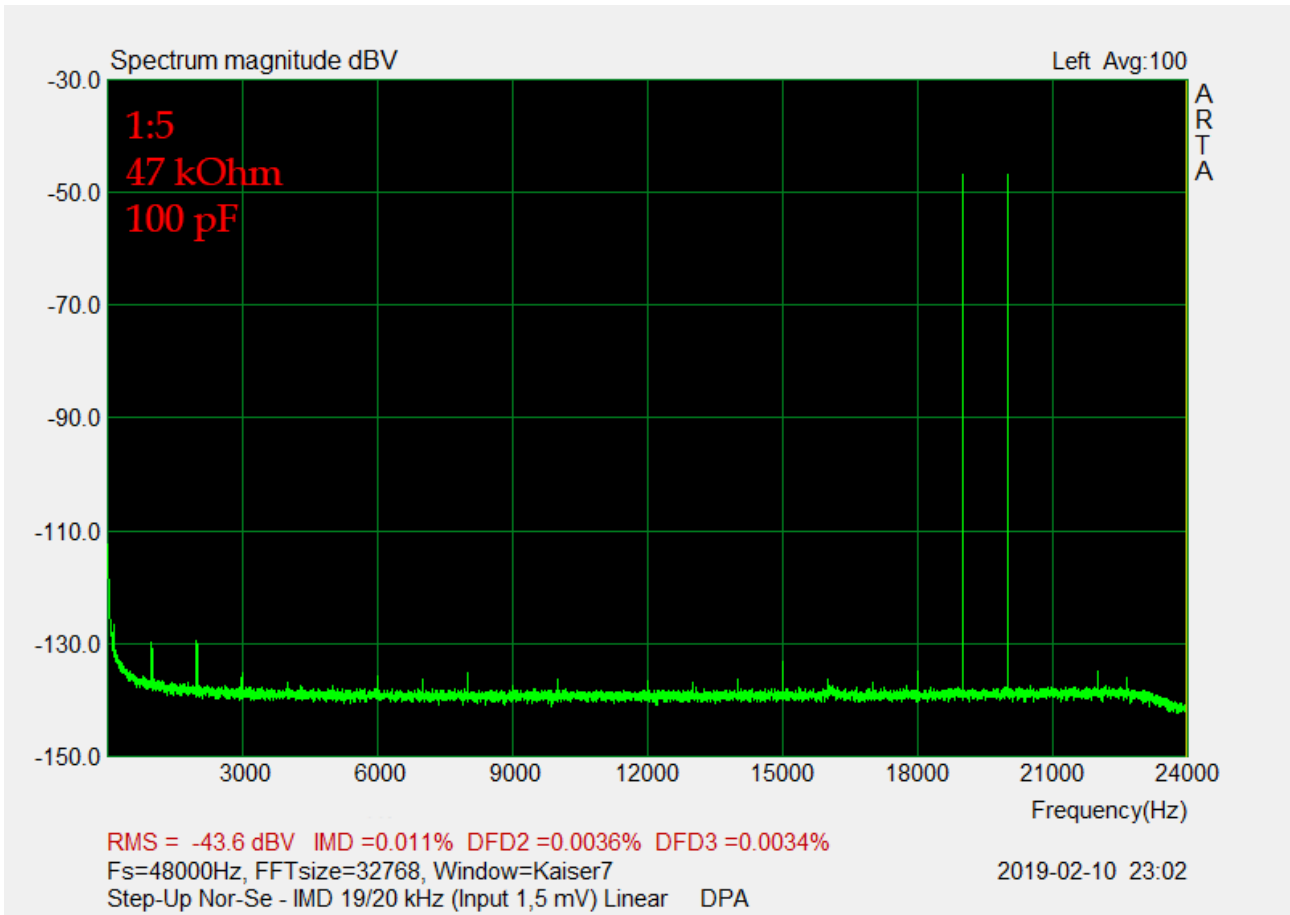

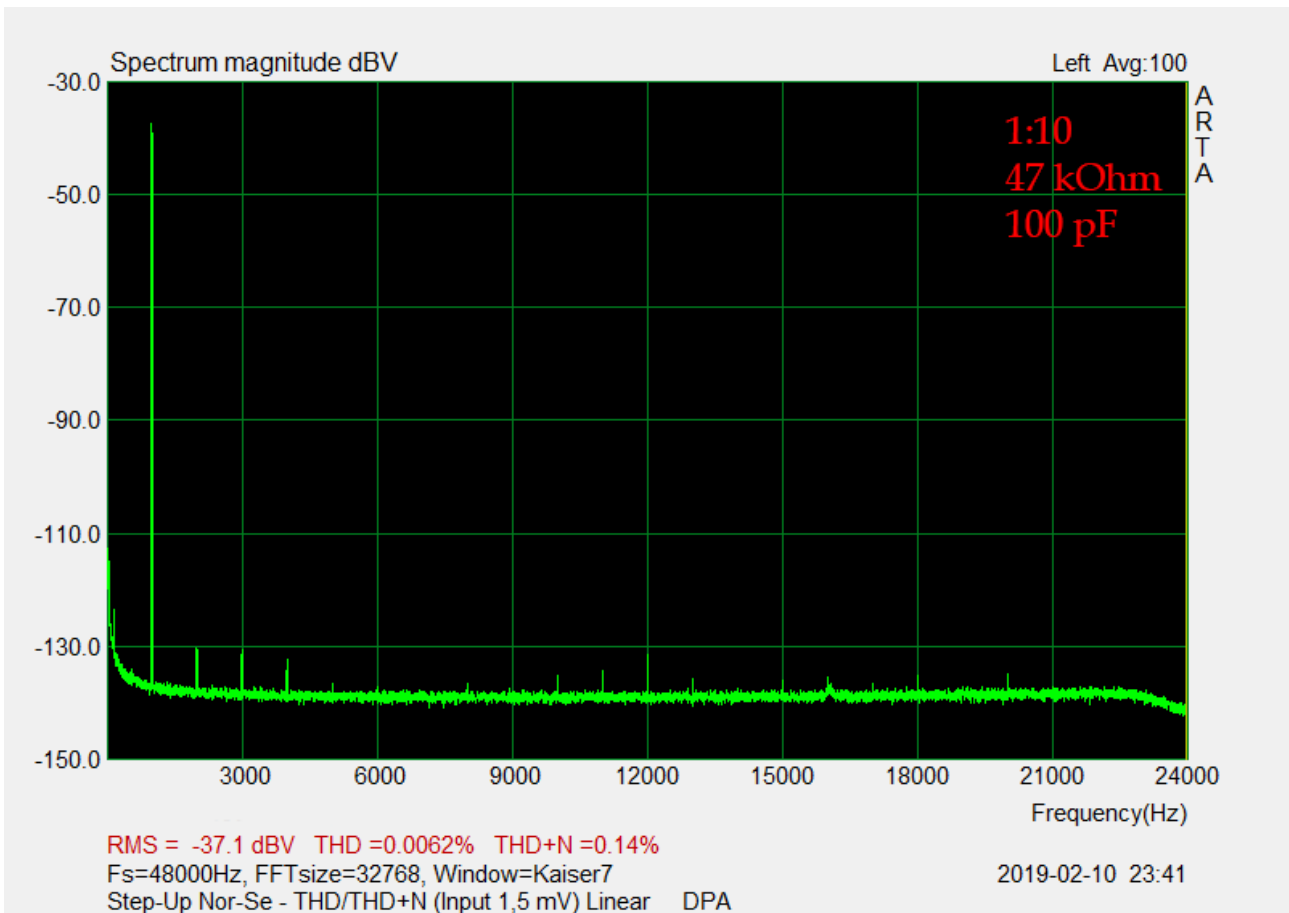
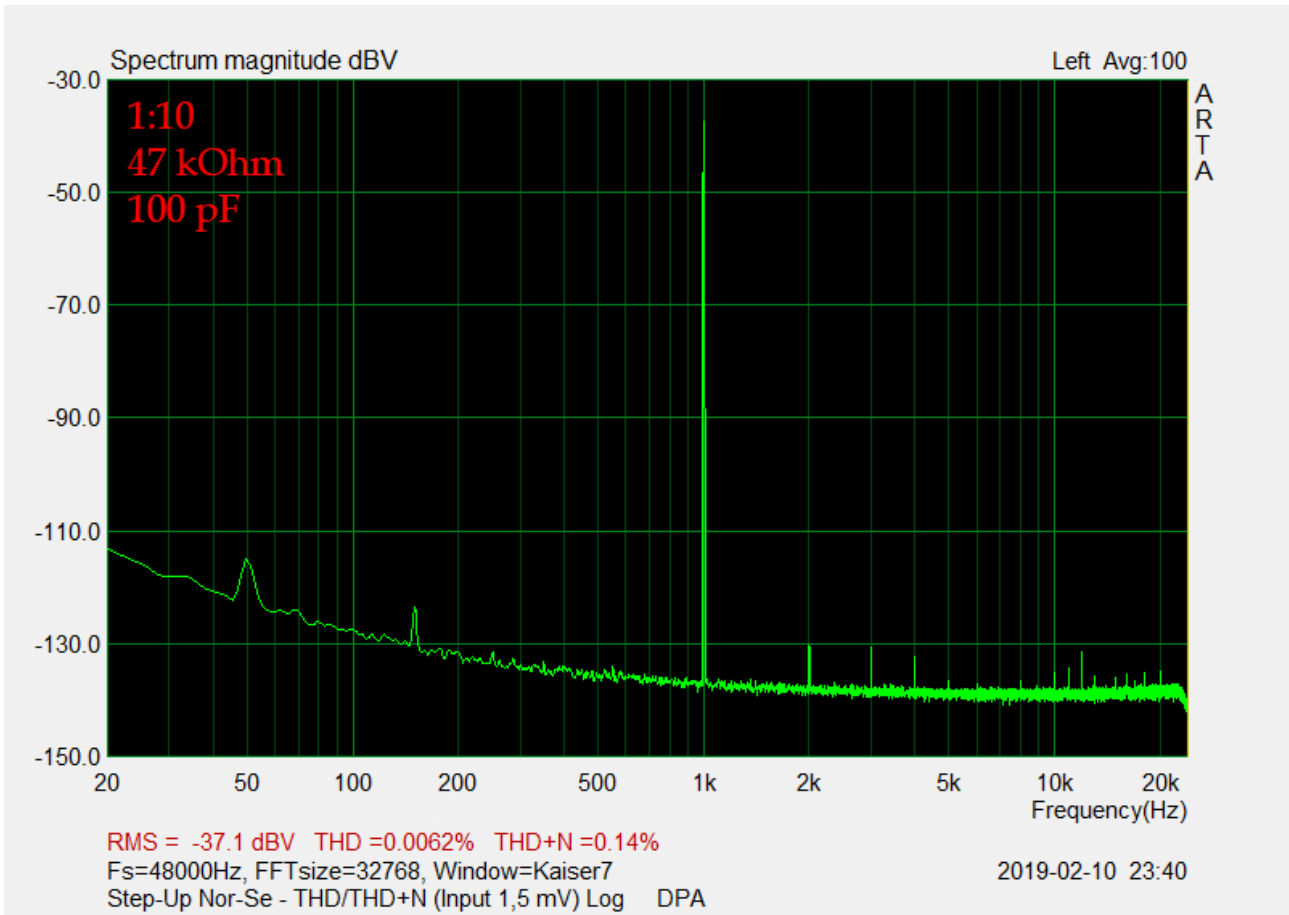

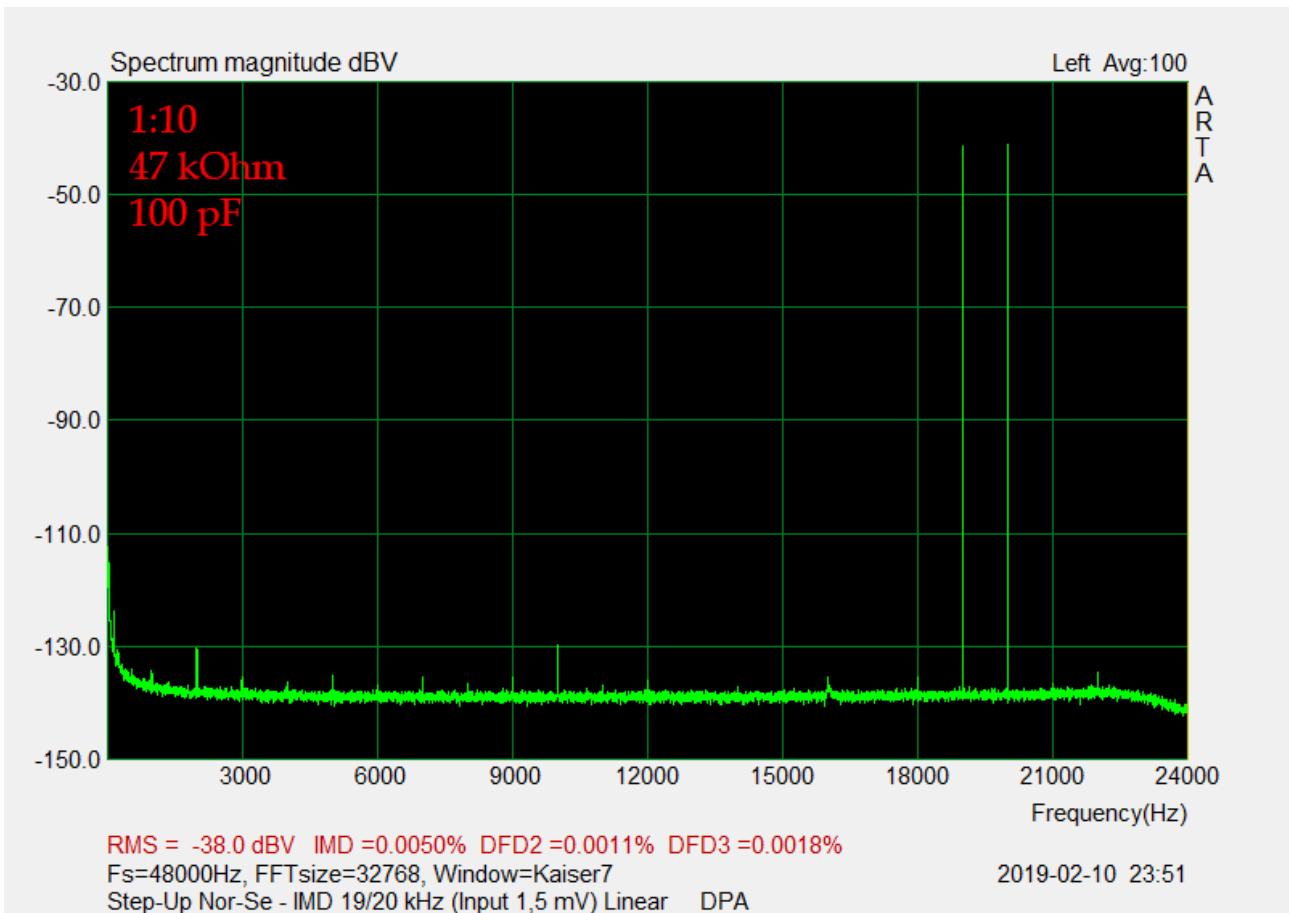
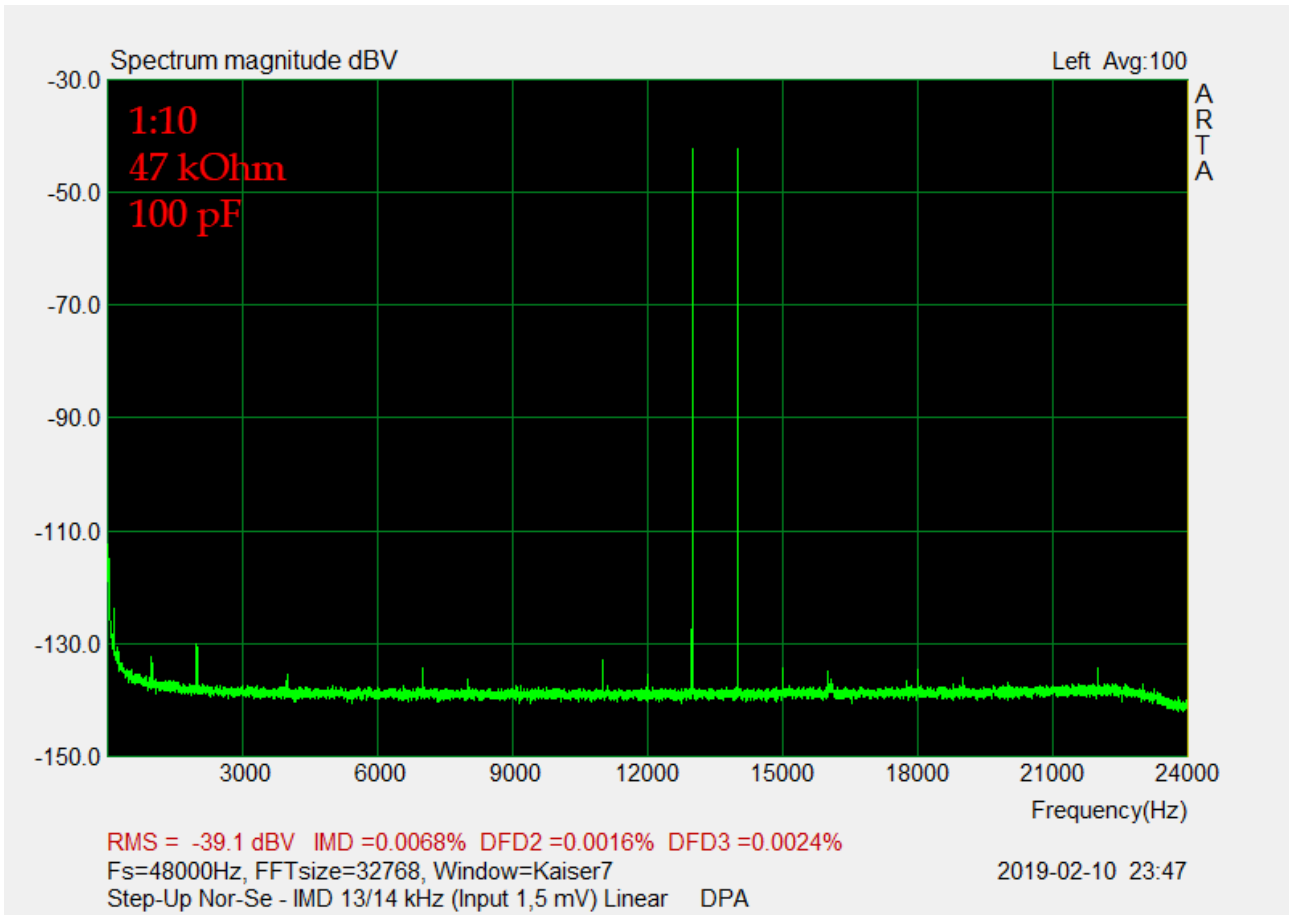

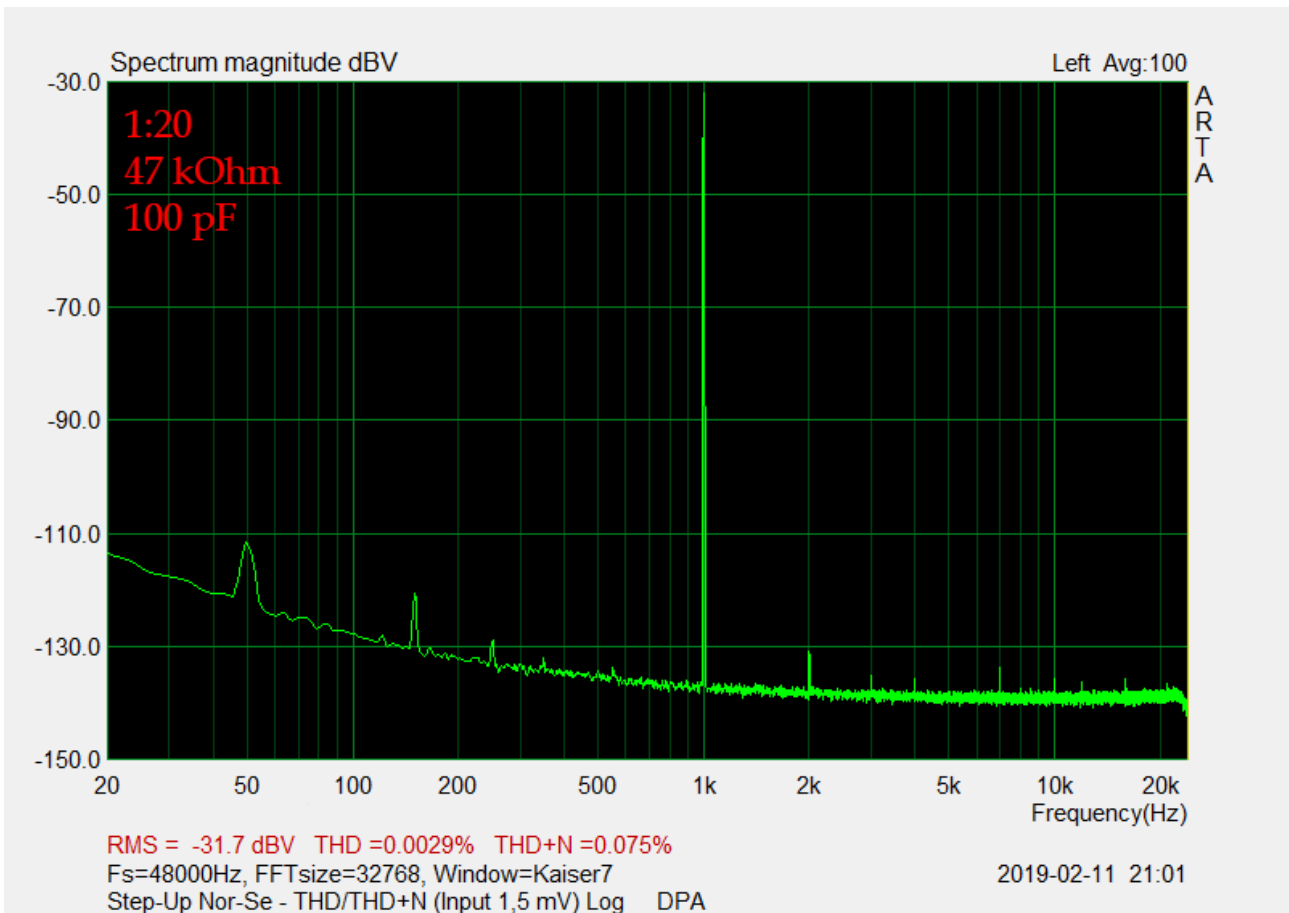
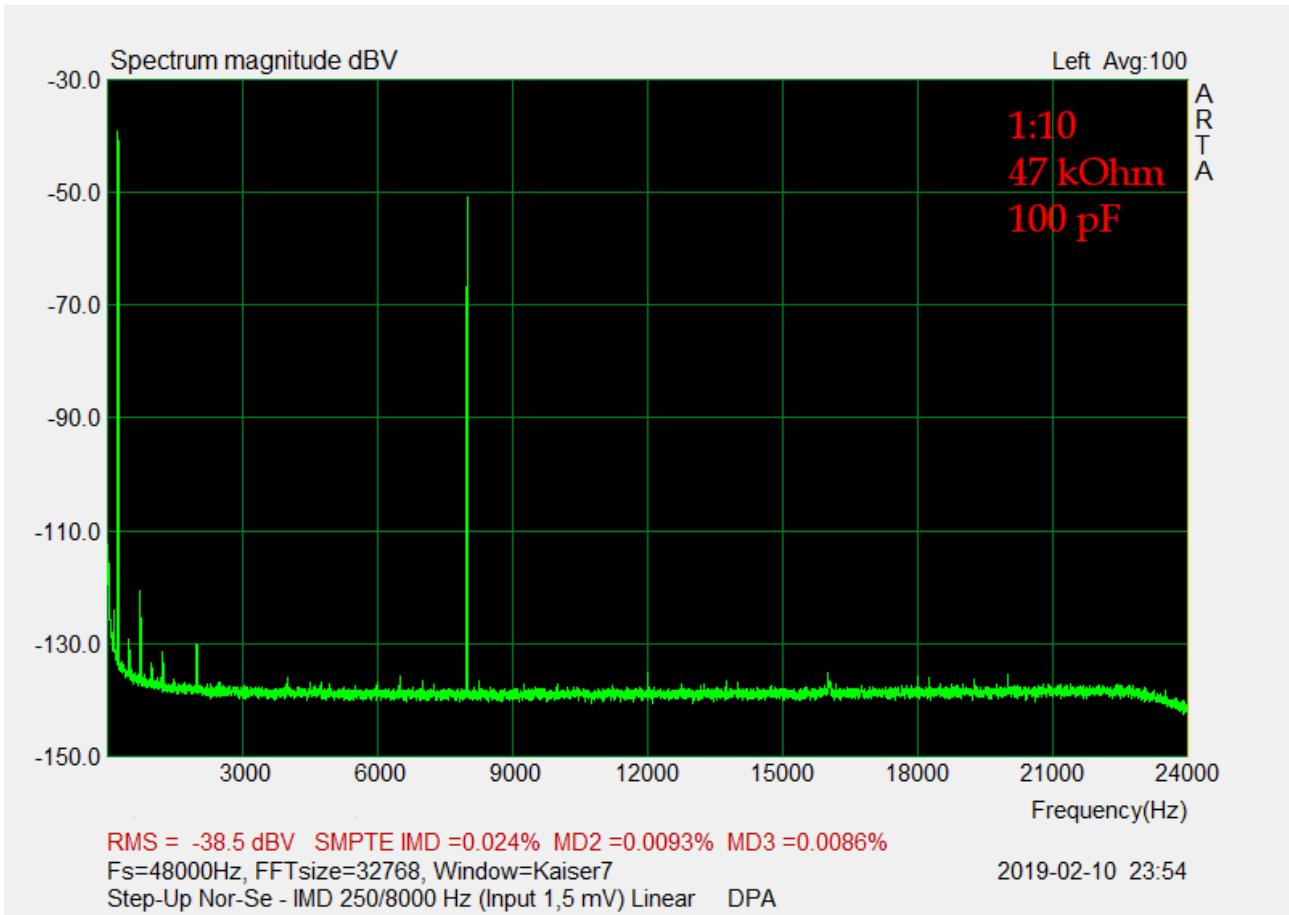

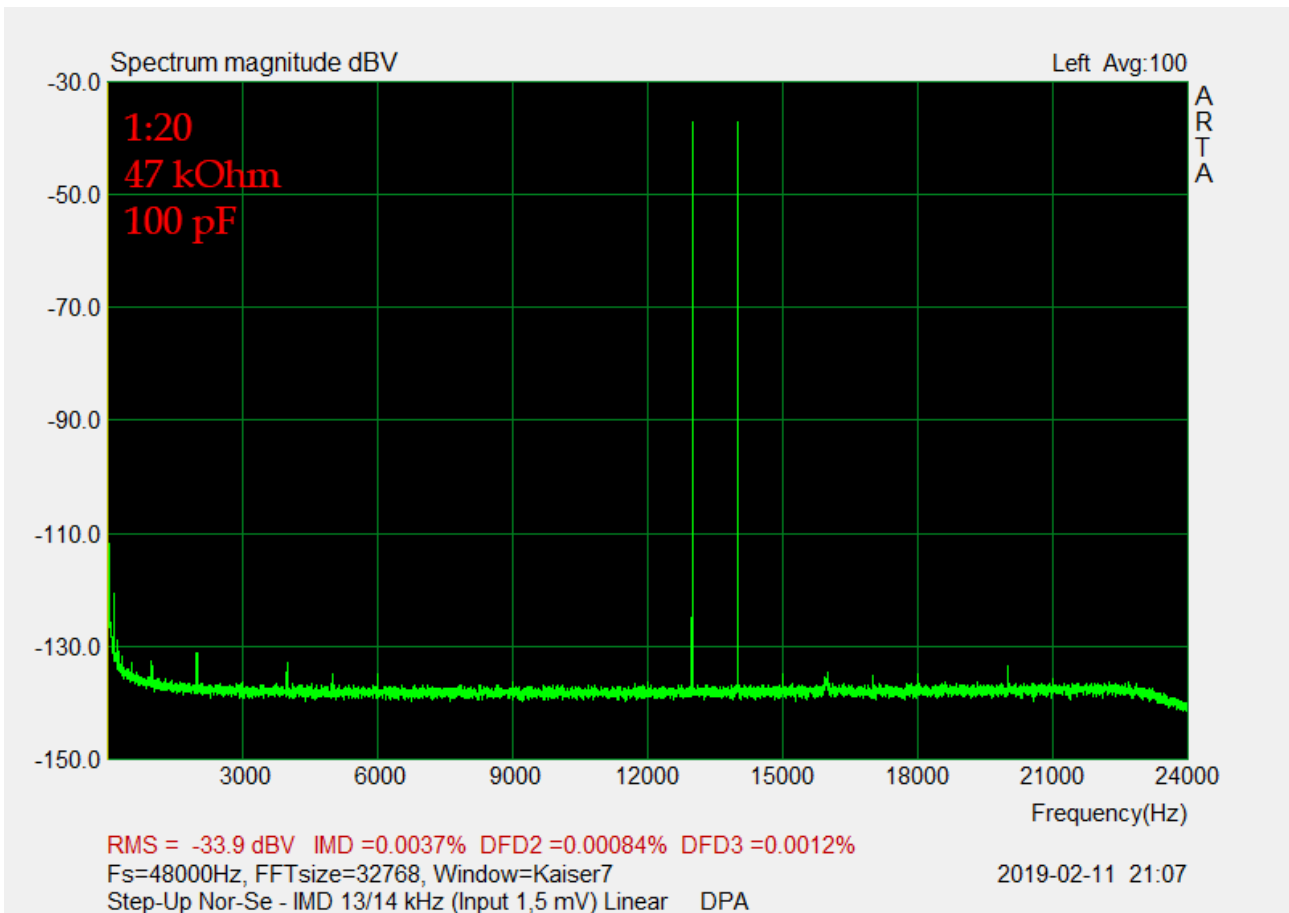
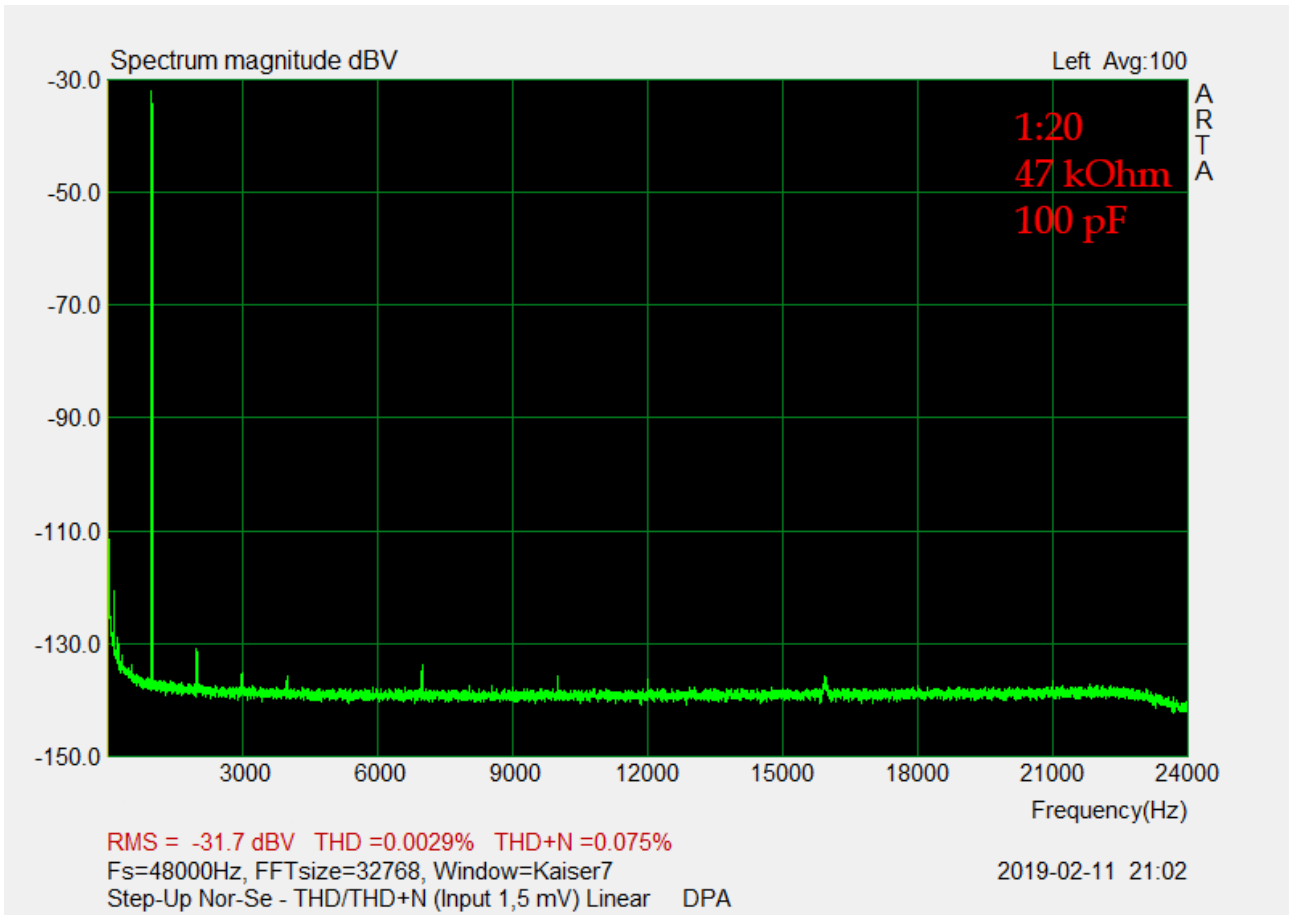

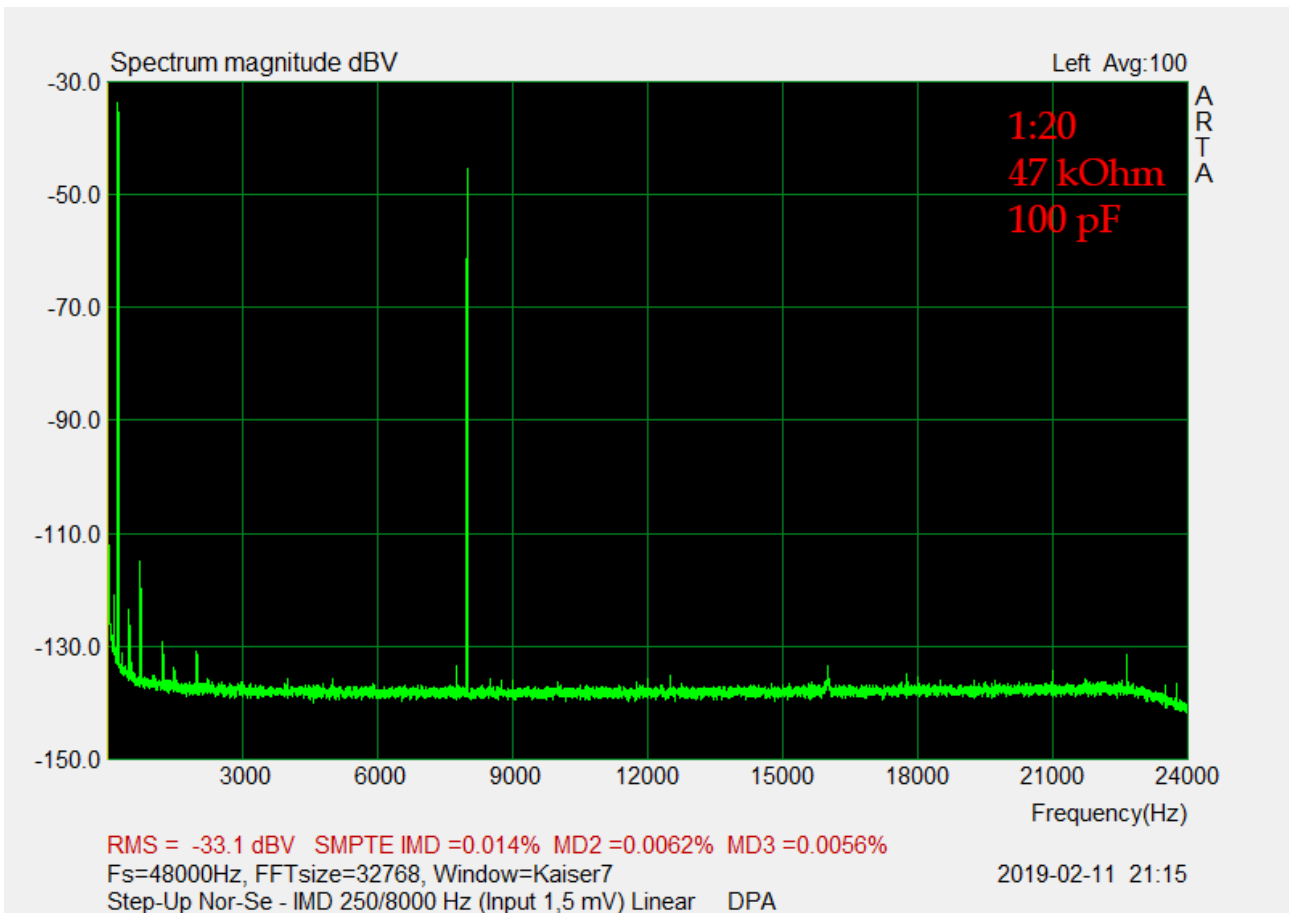
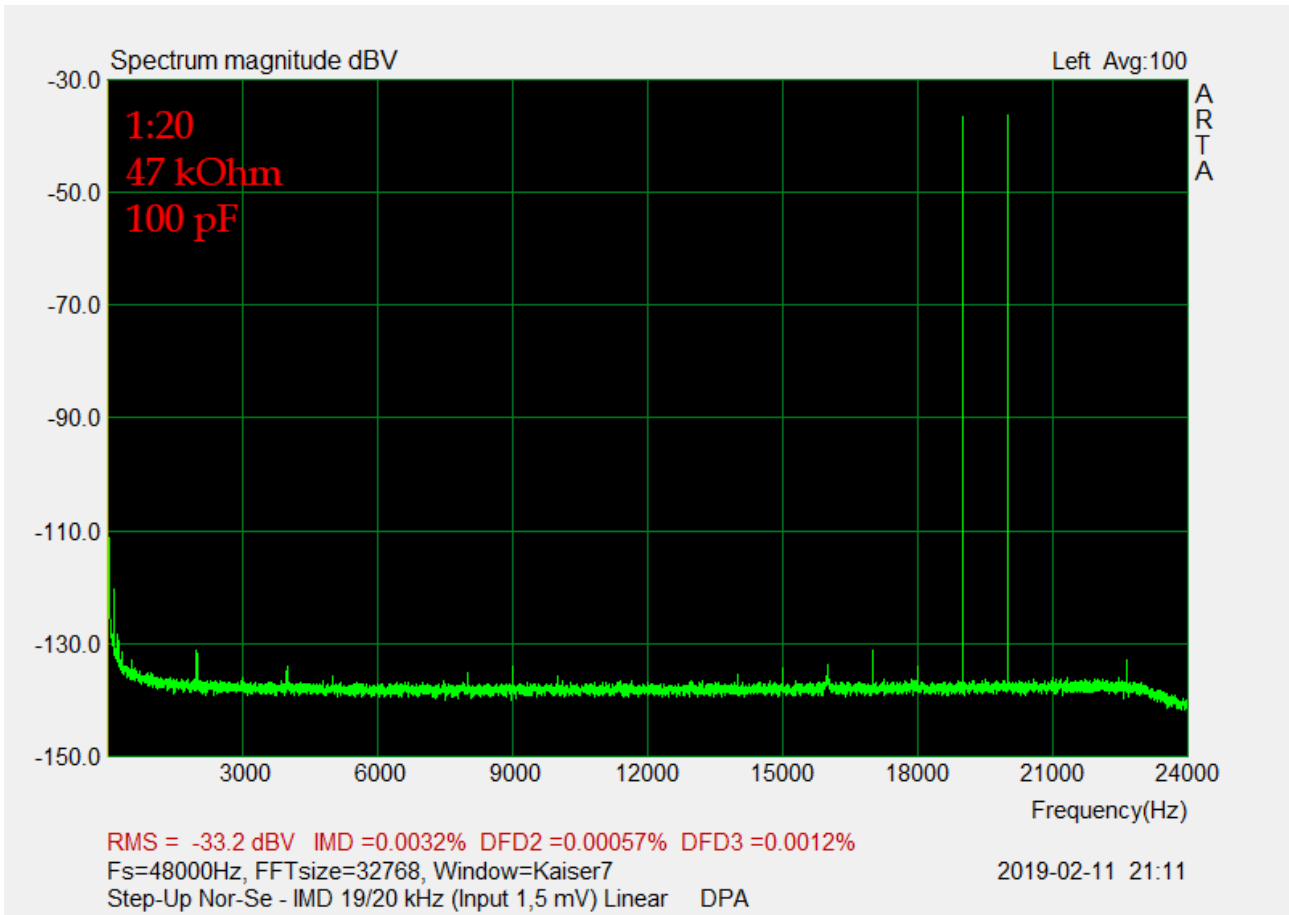

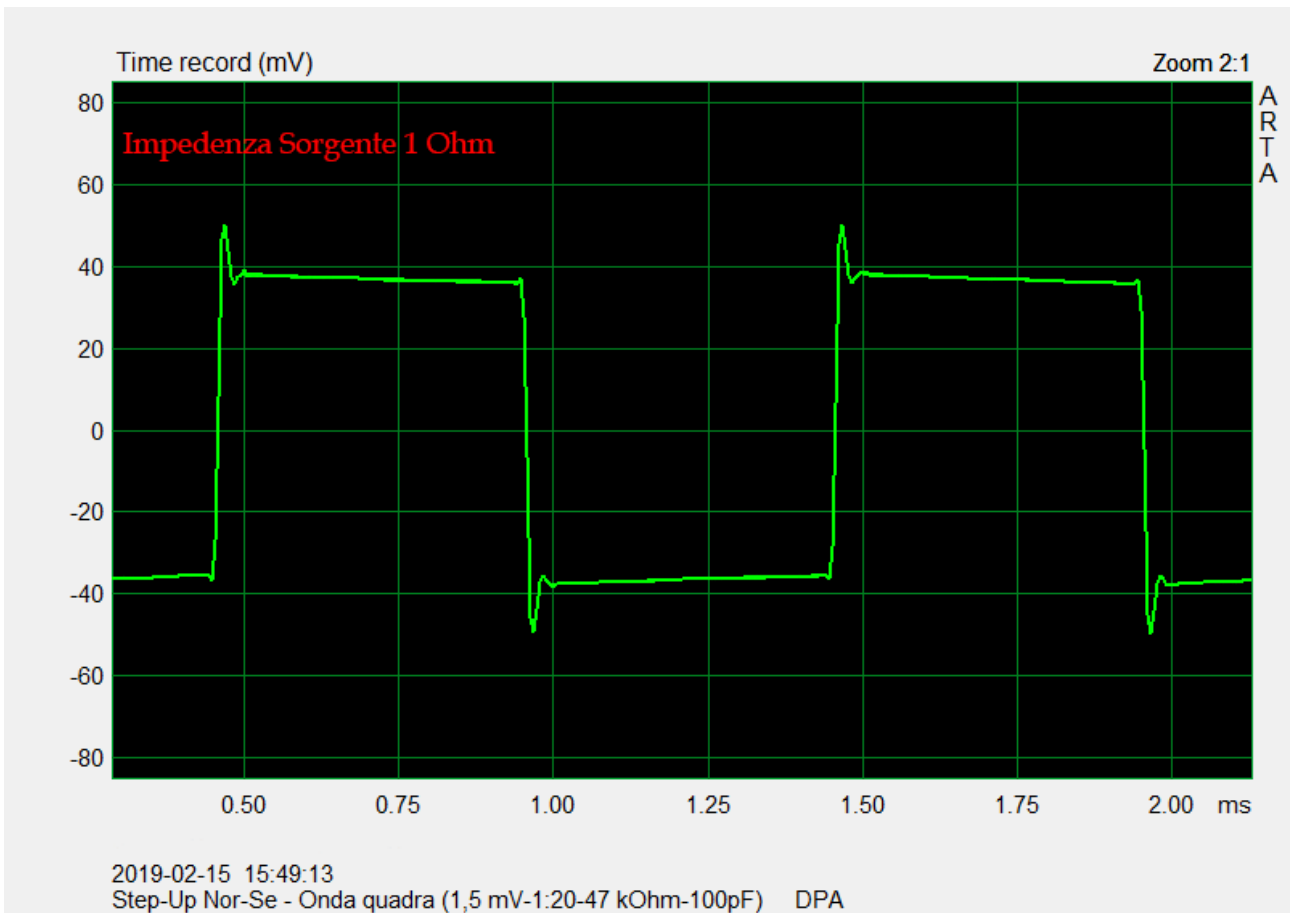
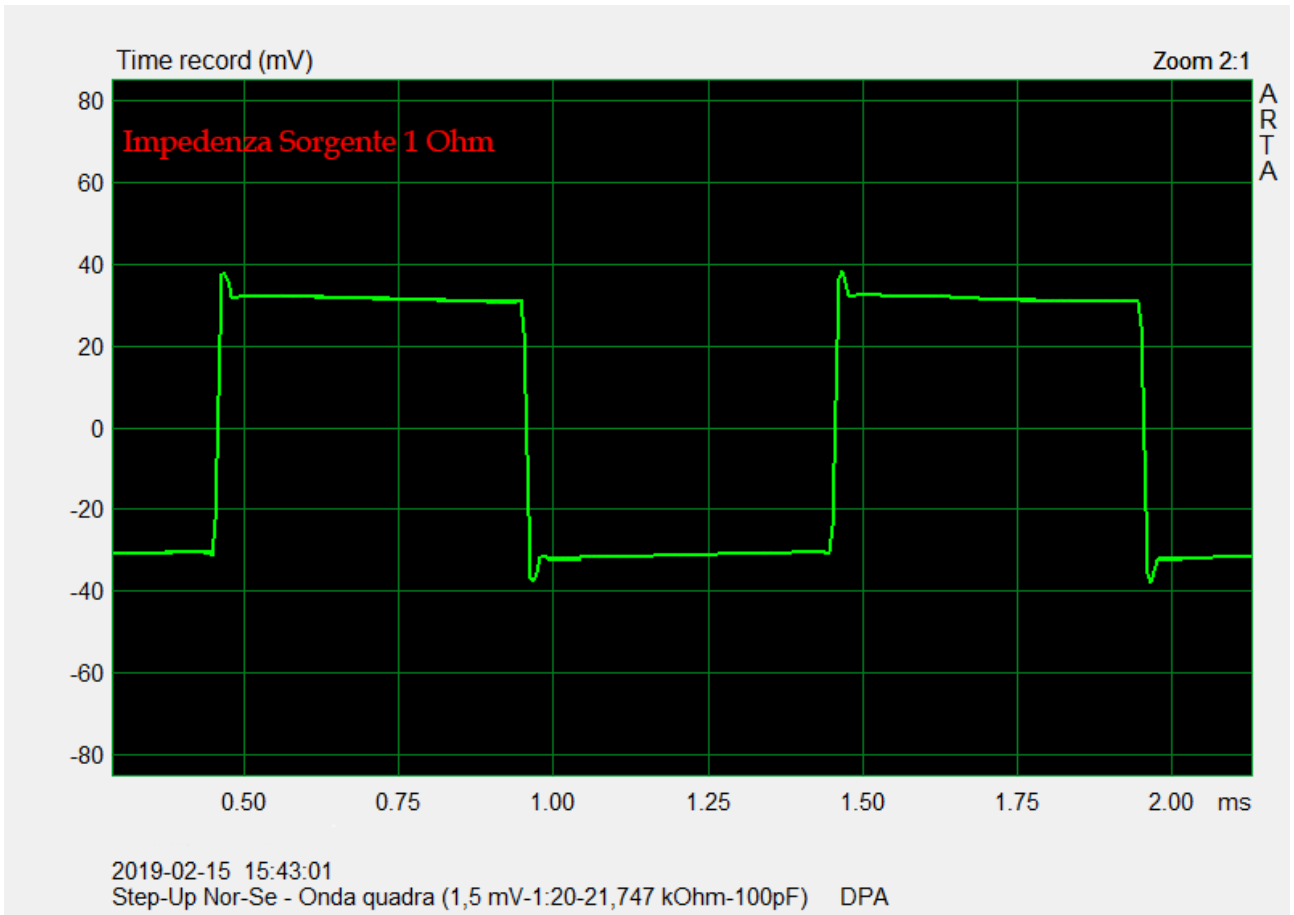

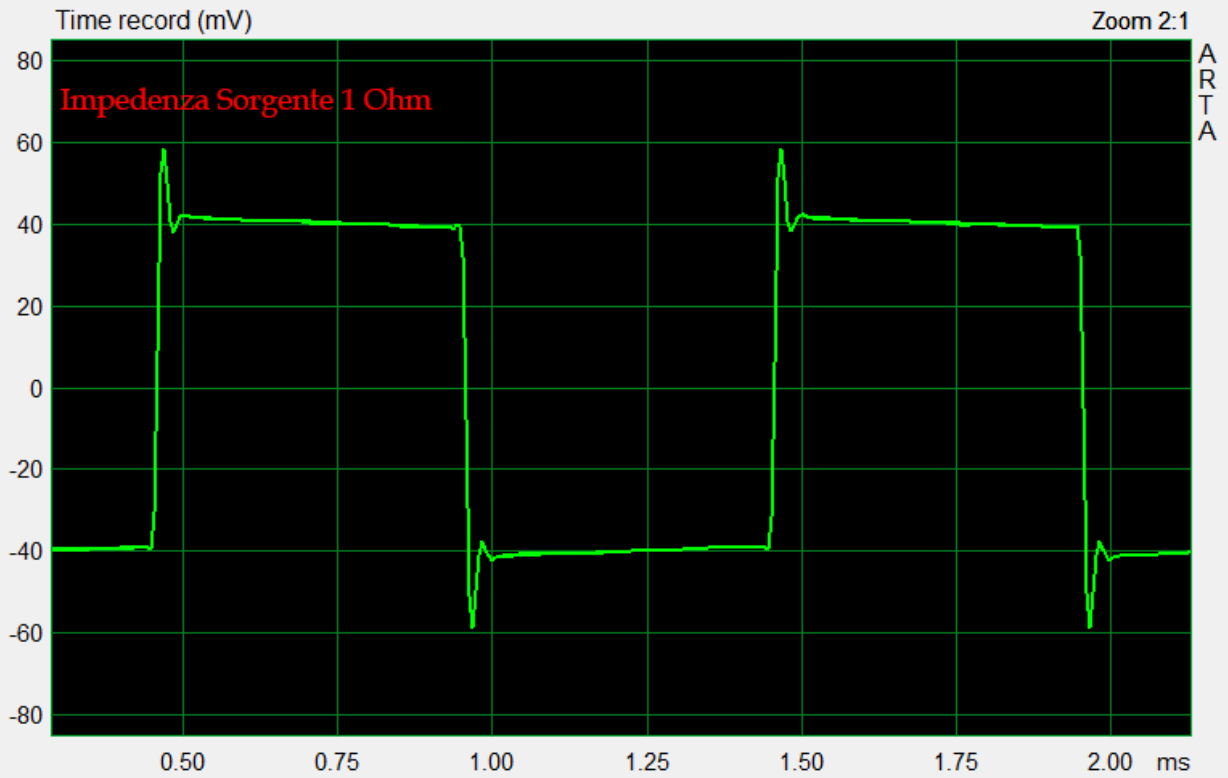

2019-02-15 15:51:52
Step-Up Nor-Se - Onda quadra (1,5 mV-1:20-100 kOhm-100pF) DPA

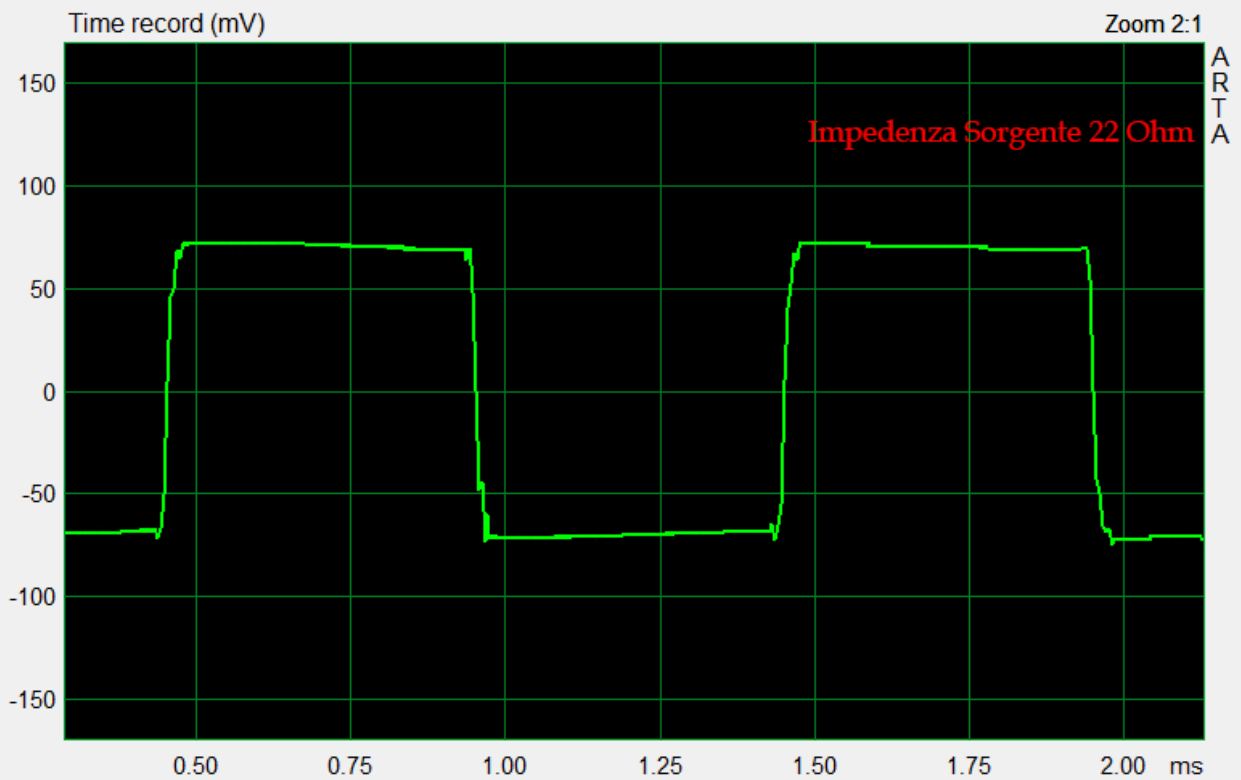

2019-02-15 17:53:33
Step-Up Nor-Se - Onda quadra 1:20 / 21,747 kOhm / 100 pF DPA

